

TERRY SCHMIDTBAUER
Director

ALLAN CALDER
Planning Services Manager

DEPARTMENT OF RESOURCE MANAGEMENT



**SOLANO
COUNTY**

675 Texas Street, Suite 5500
Fairfield, CA 94533-6342
(707) 784-6765
Fax (707) 784-4805

www.solanocounty.com

ZONING ADMINISTRATOR STAFF REPORT

Application Number:	MU-21-07	Hearing Date:	August 5, 2021
CAMS Site Number(s):	312107	Project Planner:	<u>Travis Kroger</u>
Applicant:	A2M2 LLC Chad Frazier P.O. Box 604 Winters, CA 95694	Property Owner:	Pierson Properties LLC Ted Fremouw 149 Cherokee Court Vacaville, CA 95688

Action Requested:

Consideration of Minor Use permit application MU-21-07 to establish an outdoor RV and boat storage business with a repair and maintenance garage located at 9110 Winters Road, 0.15 miles south of the City of Winters in the Commercial Service (CS) zoning district, APN 0103-160-050.

No other changes to the site or new development are proposed.

DECISIONMAKER FOR THIS APPLICATION:

() Administrative (x) Zoning Administrator () Planning Commission () Board of Supervisors

Applicable Zoning Sections: 28.74.10(A) & (B)(3), 28.76.20(A)

Subject Property Information:

Parcel Size:	2.06 acres	Site Address:	9110 Winters Road
APN(s):	0103-160-050	CALFIRE State Responsibility Area Designation:	N/A
Zoning District:	Commercial Service (CS)	General Plan Designation:	Service Commercial
Ag. Contract:	N/A	Utilities:	Private well and on-site septic system

Adjacent General Plan Designation, Zoning District, and Existing Land Use

	General Plan	Zoning
North	Service Commercial	Commercial Service (CS)
South	Agriculture	Exclusive Agriculture (A-40)
East	Agriculture	Exclusive Agriculture (A-40)
West	Agriculture	Exclusive Agriculture (A-40)

Environmental Analysis Class I Categorical Exemption CEQA Guidelines Section 15301, minor alteration of existing public or private structures.

Motion to Approve

The Zoning Administrator does hereby ADOPT the attached resolution and **APPROVE** Minor Use Permit MU-21-07, based on the enumerated findings and subject to the recommended conditions of approval.

BACKGROUND

Existing Development:

The existing development on the parcel includes a shop building, fencing around the perimeter of the parcel, and several temporary structures (shipping container, commercial coach) are visible in the most recent aerial image dated October 21, 2020. Also see Attachment g, Permit History.

Legal Lot Status:

Prior development has been approved on this parcel, so it is considered a buildable parcel by Solano County.

Aerial Image:



SETTING

Access: This site is accessed via encroachment from Winters Road, a public road.

Surrounding uses: Vacant land and other commercial uses to the north, with residential uses to the south, east and west.

PROJECT DESCRIPTION

The project site has been used for storage in the past, and is mostly flat and covered in gravel, with fencing around the perimeter. The proposed use includes establishing an RV and boat storage business open to the public, with use of the existing shop building as an office. Within 6 months of approval of this permit, the driveway access and shop building will be upgraded as needed to serve the proposed use. As a future phase, an additional building will be constructed and used for maintenance and minor repairs to boats and RVs.

No other changes to the site or land use are proposed.

ZONING & LAND USE CONSISTENCY FINDINGS

General Standards: The existing used and proposed revision meets all standards listed in Section 28.72.10 of the Solano County Code (also see attachment A).

Specific Standards: The proposed general service and RV and boat repair use meets the requirements of Sections 28.76.20 and 28.74.10 (A) & (B)(3) of the Solano County Code, see attachment E.

RECOMMENDATION

Staff recommends that the Zoning Administrator **ADOPT** the mandatory and suggested findings detailed in attachment A and **APPROVE** Minor Use Permit MU-21-07 subject to the recommended conditions of approval.

ATTACHMENTS

- a) Draft Resolution
- b) Conditions of approval
- c) Assessor's Parcel map
- d) General zoning consistency checklist
- e) Specific zoning consistency checklist
- f) Draft Plans
- g) Permit history

**SOLANO COUNTY ZONING ADMINISTRATOR
RESOLUTION NO. XX-XX**

WHEREAS, the Solano County Zoning Administrator has considered Minor Use permit application MU-21-07 to establish an outdoor RV and boat storage business with a repair and maintenance garage located at 9110 Winters Road, 0.15 miles south of the City of Winters in the Commercial Service (CS) zoning district, APN 0103-160-050, and;

WHEREAS, said Zoning Administrator has reviewed the report of the Department of Resource Management and heard testimony relative to the subject application at the duly noticed public hearing held on August 5, 2021, and;

WHEREAS, after due consideration, the Zoning Administrator has made the following findings in regard to said proposal:

- 1. That the establishment, maintenance or operation of the use or building is in conformity to the General Plan for the County with regard to traffic circulation, population densities and distribution, and other aspects of the General Plan considered by the Zoning Administrator to be pertinent.**

This project is located within an area designated Service Commercial by the Solano County General Plan Land Use Diagram. The proposed uses are conditionally permitted within the Commercial Service (CS) zoning district.

- 2. Adequate utilities, access roads, drainage and other necessary facilities have been or are being provided.**

The site is provided with water by private well and sewer service by an on-site sewage disposal system. Access is via encroachment off Winters Road.

- 3. The subject use will not, under the circumstances of this particular case, constitute a nuisance or be detrimental to the health, safety, peace, morals, comfort or general welfare of persons residing or working in or passing through the neighborhood of such proposed use or be detrimental or injurious to property and improvements in the neighborhood or to the general welfare of the County.**

As conditioned, the proposed RV and boat storage business and RV and boat repair use will not constitute a nuisance to surrounding properties, nor will it be detrimental to the health, safety, or welfare of County residents.

- 4. The project qualifies for a Class I Categorical Exemption from the California Environmental Quality Act pursuant to CEQA Guidelines Section 15301, minor alteration of existing public or private structures.**

BE IT THEREFORE RESOLVED, that the Zoning Administrator has approved Minor Use permit MU-21-07 subject to the recommended conditions of approval contained in attachment B.

* * * * *

I hereby certify that the foregoing resolution was adopted at the regular meeting of the Solano County Zoning Administrator on August 5, 2021.

Allan M. Calder, Planning Manager
Resource Management

MU-21-07 CONDITIONS OF APPROVAL

General

1. The above use shall be established in accord with the application materials and development plans as submitted with MU-21-07 filed May 7, 2021 and as approved by the Solano County Zoning Administrator.
2. Within 30 days of issuance of MU-21-07, the applicant will submit final development plans reflecting all conditions of approval as approved by the Solano County Zoning Administrator. Plans should include any existing shipping containers on the parcel and note whether they will be removed within 6 months or permitted for permanent use and remain on the parcel. Once the revised plans have been submitted and approved, a Business License application may be submitted as well.
3. Prior to installation of any signage, the applicant will obtain a Sign Permit and install the signs in compliance with the approved plans and conditions of approval.
4. Prior to conducting the use approved by this permit, the applicant will obtain a Business License and maintain the license in good standing for as long as the business remains in operation.
5. The permittee shall take such measures as may be necessary or as may be required by the County to prevent offensive noise, lighting, dust or other impacts, which constitute a hazard or nuisance to surrounding properties.
6. Any expansion or change in the use or new or expanded buildings may require a Minor Revision or Amendment to the existing Minor Use permit or a new permit if determined to be necessary by the Director of the Department of Resource Management.
7. The premises shall be maintained in a neat and orderly manner and kept free of accumulated debris and junk.

Environmental Health Division

The following items will be completed within 6 months of permit issuance:

8. The applicant shall have a Site and Soil Evaluation performed under Environmental Health permit. The Site and Soil Evaluation report will need to show that the property has an adequate septic reserve area and determine the site-specific seasonal groundwater level and any subsurface restrictive layers which may be encountered at the property. All primary and reserve leachfield areas shall need to meet the minimum setback distances of 100 ft. from all water wells, streams, and reservoirs, 50 ft. from all unlined culverts and 25 ft. from all property lines.
 - A. The Site and Soil report shall include a map which shows the location of all water wells within 100 ft. of the property, the location of the existing septic tank and leachfield, and the designated septic reserve area.
9. Discharge of waste oil and other hazardous materials is not permitted. The applicant shall provide a description or narrative detailing how operations will prevent the discharge of waste oil and other hazardous materials to the ground and into the septic system.
10. The applicant shall create a profile within the California Environmental Reporting System (CERS) website, and submit a complete Hazardous Materials Business Plan (HMBP) within 30 days of bringing on hazardous materials in reportable quantities.

Building and Safety Division

Within 6 months of permit issuance, the applicant or property owner will obtain Building Permits as needed for any existing as-built development, new development, occupancy changes or new structures subject to conditions 10-17 below.

11. Prior to any construction or improvements taking place, a Building Permit Application shall first be submitted as per Section 105 of the 2019 California Building Code. "Any owner or authorized agent who intends to construct, enlarge, or change the occupancy of a building or structure shall first make application to the building official and obtain the required permit."
12. Certificate of Occupancy "111.1 Use and Occupancy. No building shall be used or occupied, and no change in the existing occupancy classification of a building or structure or portion thereof shall be made until the building official has issued a certificate of occupancy therefore as provided herein."
13. The site and all facilities shall meet all of the accessibility requirements found in Chapter 11B of the 2019 California Building Code. The designer is required to design for the most restrictive requirements between ADA Federal Law and the 2019 California Building Code. The Solano County Building Division will be reviewing the plans for the most restrictive requirements of the two. There shall be a complete site plan, drawn to scale, and designed by a licensed architect reflecting all site accessibility.
14. All accessible paths of travel and parking areas shall be a hard-scaped surface and shall meet all of the worst case requirements between Chapter 11B of the 2019 California Building Code and the ADA Federal Law. One ADA parking shall be provided per every 25 parking stalls.
15. The building permit plans shall include a code analysis as listed below and the design shall be under the 2019 California Codes and all current rules, regulations, laws and ordinances of the local, state and federal requirements. Upon building permit submittal, the licensed architect shall provide a code analysis for each building or structure such as:
 - a. Occupancy Classification
 - b. Type of Construction
 - c. Occupant Load
16. Plans and Specifications shall meet the requirements as per Section 105 of the 2019 California Building Code. "Construction documents, statement of special inspections and other data shall be submitted in one or more sets with each permit application. The construction documents shall be prepared by a registered design professional where required by the statutes of the jurisdiction in which the project is to be constructed. Where special conditions exist, the building official is authorized to require additional construction documents to be prepared by a registered design professional." Electronic media documents are permitted when approved by the building official. Construction documents shall be of sufficient clarity to indicate the location, nature and extent of the work proposed and show in detail that it will conform to the provisions of this code and relevant laws, ordinances, rules and regulations, as determined by the building official."
17. The fire district will reassess the site for fire life and safety requirements.
18. An Automatic residential fire sprinkler system shall be installed throughout the building.

Public Works Division

Conditions 18-19 below will be completed within 6 months of the date of permit issuance.

The applicant shall build two commercial driveways for the entrances to the parking lot. These driveways will be built to Solano County Road Standard and include tapers.

19. Applicant shall apply for, secure and abide by the conditions of an encroachment permit for any work within the public right-of-way. Driveways must be maintained in such a manner as to prevent soil, rocks, and debris from tracking onto public roads.
20. Applicant shall apply for, secure and abide by the conditions of a grading permit for any grading on the property including, but not limited to, building site preparation, private access improvements, parking areas and walkways, as well as any onsite grading exceeding a total of 5,000 square feet.
21. No signs for the business allowed in the right of way for Winters Road.

Permit Term

22. The Department of Resource Management shall verify ongoing compliance with the terms and conditions of this permit through a program of periodic renewals occurring at five (5) year intervals from the date of granting this permit. The cost associated with the periodic renewals shall be charged at that time.

POR. LOT 37 RANCHO RIO DE LOS PUTOS
 POR. SEC'S. 22, 27 & 28, T.8N., R.1W., M.D.B. & M. EXT.

Tax Area Code
 77002

103-16

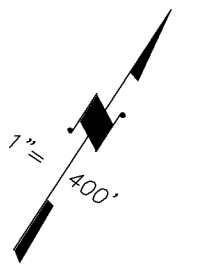

Copyright © 1996, Solano County Assessor/Recorder. All rights Reserved

1.	S.23°35'56"W.	70.28'
2.	R=580' L=	111.65'±
3.	S.41°10'E.	239.89'±
4.	S.48°50'W.	100.00'
5.	N.41°10'W.	204.53'±
6.	S.36°31'50"W.	47.44'±
7.	N.43°44'39"E.	120.23'
8.	N.40°40'10"W.	132.00'
9.	S.01°13'E.	172.72'
10.	S.24°57'50"W.	67.32'
11.	N.24°43'W.	261.71'
12.	R=340' L=	56.22'±
13.	R=580' L=	153.71'
14.		
15.		

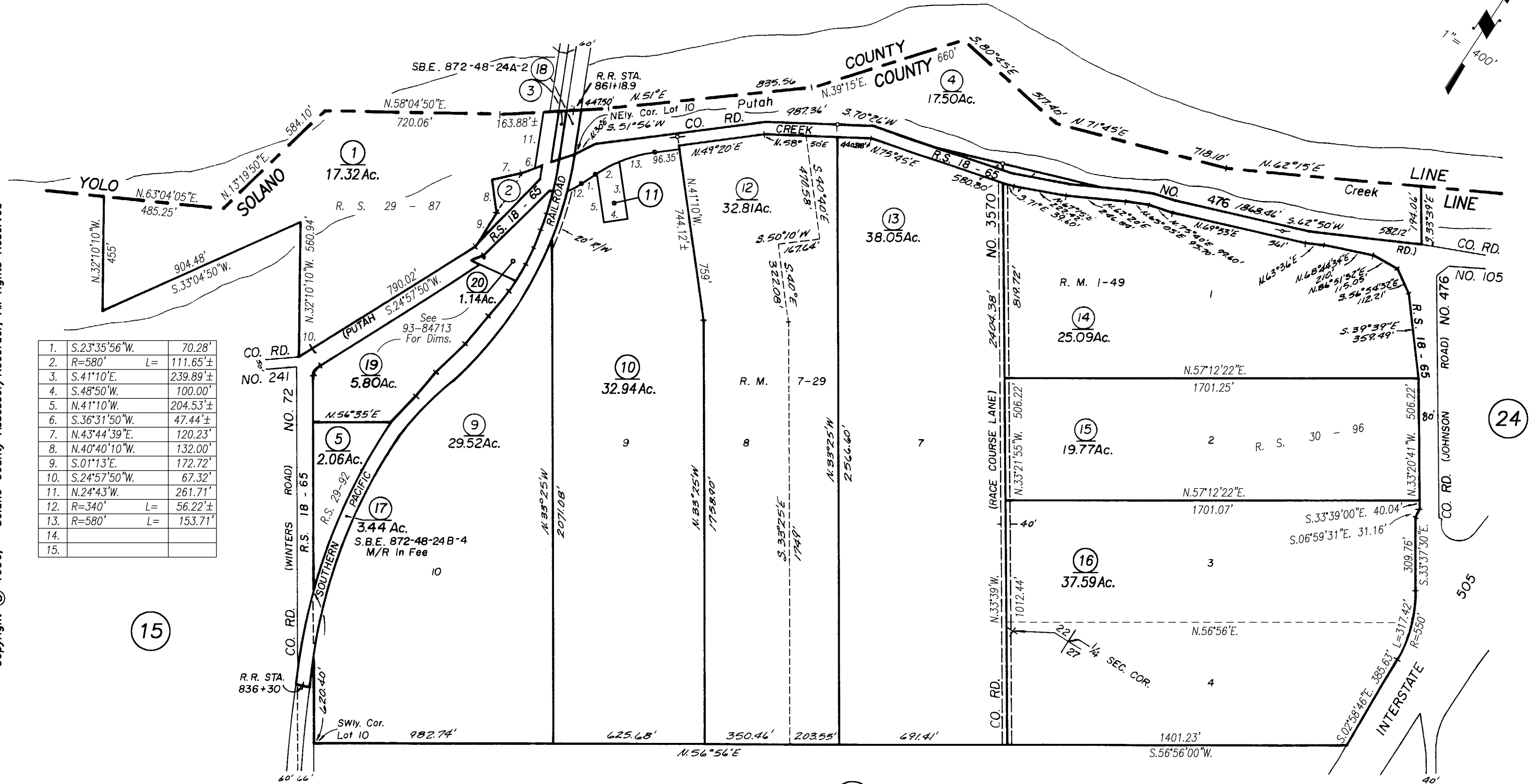

15

17

1/4
 Sec. Cor.

Wm. Baker Tract,
 County Road No. 476,
 Heirs of M.J.Baker,

, R.M. Bk.01 Pg. 49
 ; R.M. Bk.02 Pg. 71
 ; R.M. Bk.07 Pg. 29

Assessor's Block Numbers Shown in Ellipses, Assessor's Parcel Numbers Shown in Circles

160-15 (Rs)	4-10-13	Cr
160-16 Chg.(Lla)	4-26-13	Cr
160-01 Chg.(Dd)	8-16-12	Cr
160-10,11 Chg.(Dd)	8-16-12	Cr
REVISION	DATE	BY

NOTE: This map is for assessment purposes only. It is not intended to define legal boundary rights or imply compliance with land division laws.

Assessor's Map Bk.103 Pg. 16
 County of Solano, Calif.

14-15



General Development Standards Checklist (Section 28.70.10)

Application Number: MU-21-07

No use of land or buildings shall be conducted except in compliance with these general development standards.				
A. Zoning District Standards	YES	MAYBE	NO	N/A
Any use of land or buildings must meet the general development standards described in this section unless more stringent permitting and development standards are delineated in the applicable zoning district.				
B. Performance Standards				
1. Prevent Offensive Noise, Dust, Glare, Vibration, or Odor. All uses of land and structures shall be conducted in a manner, and provide adequate controls and operational management to prevent:				
a. Dust, offensive odors, or vibrations detectable beyond any property line;	x			
b. Noise that exceeds 65dBA LDN at any property line	x			
c. Glint or glare detectable beyond any property line or by overflying aircraft	x			
2. Prevent Storm Water Pollution. Any use of land or buildings shall contain measures to manage storm water to prevent any potential contaminants, processing wastes or by-products from entering any natural or constructed storm water facility or canal, creek, lake, pond, stream or river.				
3. Parking. Adequate off-street parking shall be provided pursuant to Section 28-94; parking areas and driveways shall be treated as necessary to control dust. Parking areas shall not be located any closer than 200 feet to an adjoining property. Shall provide off-street parking in accordance with Section 28-94 in addition to paved parking spaces, aisles and pathways for the disabled in accordance with Building Code.				
4. Removal of Natural Material. Removal of natural material 1) shall prevent offensive noise, dust, vibrations or standing water from occurring beyond any property line; 2) shall not create finished grades of a greater slope than two to one; and 3) shall be so located that generated traffic will not constitute a hazard or nuisance to surrounding property.				
5. Solid Waste and General Liquid Waste Storage and Disposal.				
a. All uses are prohibited from discharging liquid, solid, toxic, or hazardous wastes onto or into the ground and into streams, lakes, or rivers except as allowed by applicable local, State and federal laws and regulations.	x			

b. The handling and storage of hazardous materials, the discharge of hazardous materials into the air and water, and the disposal of hazardous waste in connection with all uses shall be in conformance with all applicable local, State and federal regulations.	x			
c. All burning of waste materials accessory to any use shall comply with the Yolo-Solano Air Quality Management District or the San Francisco Bay Area Air Quality Management district based on geographic location of the activity specific to each air quality management district.				x
d. The disposal or dumping of solid wastes accessory to any use, including, but not limited to, slag, paper and fiber wastes or other industrial wastes, shall be in compliance with applicable local, State, and federal laws and regulations.				x
Note: Should the Director of Resource Management believe that a proposed use in any district is likely to violate the performance standards in B.1-8 above, the Director may invoke the performance standard procedures contained in Section 28-95 .				
C. Fairfield Train Station Specific Plan Area				
1. Uses established in the Fairfield Train Station Area, designated an Urban Project Area by the Solano County General Plan shall, be consistent with existing development and considered interim uses which terminate upon annexation to the City of Fairfield.				x
D. Airport Land Use Compatibility Plans				
1. Within an airport area of influence or area of concern depicted in an airport land use compatibility plan adopted by the Solano County Airport Land Use Commission, land uses allowed by this Zoning Ordinance shall conform with the applicable compatibility policies and criteria set forth in that airport land use compatibility plan.				x
E. Other Permits.				
1. Building and Safety Division. The Building Services Division may require a building permit and/or occupancy permit prior to conducting any use authorized by this chapter. A building permit may also be required prior to any change in the occupancy type of a previously permitted building or structure.				
a. Building Permit Required	x			
b. Occupancy Permit Required				
c. Change of Occupancy Required	x			
2. Environmental Health Services Division. The Environmental Health Services Division administers a variety of laws and regulations which may require permits prior to conducting specific land uses authorized under this chapter, including:				
a. Food facility permits				
(1) Sale and Consumption of Food and Beverage. Any use of land or buildings which provide for the sale and/or consumption of the food or beverage must meet all federal, state and local laws and regulations, including Department of Resource Management				x

Environmental Health Services Division approval (if required) prior to operation.				
(2) Food Preparation. Any use of land or buildings which provide for the sale of prepared food, must meet all federal, state and local laws and regulations, including Department of Resource Management Environmental Health Services Division approval (if required) prior to operation.				X
a. Hazardous materials and waste program permits	X			
b. Recreational health facility permits				X
c. Liquid and solid waste permits including septic system permits	X			
d. State small water system permits				X
e. Water well permits				X
3. Public Works Engineering Division. The Engineering Services Division administers a variety of regulations which may require permits including:				
a. Encroachment permits	X			
b. Grading and drainage permits				X
4. Fire Protection District. Local fire protection districts may regulate certain uses of buildings and land.				X
5. Other Agencies. Certain land uses are subject to laws and regulations administered by federal, state, regional and local agencies and may require additional licenses or permits, prior to conducting the land use. Prior to conducting any land use authorized under this chapter, any other licenses or permits required by any other agency must be obtained.				X



RETAIL USES (Automobile Repair Garages) Zoning Standards Checklist (Section 28.74.10(A) & (B)(3))

Application Number: MU-21-07

Table with 5 columns: Requirement, YES, MAYBE, NO, N/A. Rows include General Requirements (Access, Roads, Setbacks) and Specific Requirements (Automobile Repair Garages).

Horizontal lines for additional input or notes.



COMMERCIAL SERVICE USES (Section 28.76.20)

Application Number: MU-21-07

Table with 5 columns: A. General Requirements, YES, MAYBE, NO, N/A. Rows 1-10 detailing requirements like General Development Standards, Setbacks, Ingress/Egress, Trucking Access, Loading Spaces, Encroachment Permit, No Removal of Agriculture, Incidental Retail Uses, Outdoor Storage, and Adjacent to an R District.

Horizontal lines for additional information or notes.

ABBREVIATIONS

A.U.E	ACCESS & UTILITY EASEMENTS	HC	HANDICAP
BSW	BACK OF SIDEWALK	MH	MANHOLE
CO	CLEANOUT	P.U.E	PUBLIC UTILITY EASEMENT
DI	DRAINAGE INLET	SD	STORM DRAIN
DW	DRIVEWAY	SS	SANITARY SEWER
EX	EXISTING	SSCO	SANITARY SEWER CLEANOUT
FL	FLOWLINE	WS	WATER SERVICE

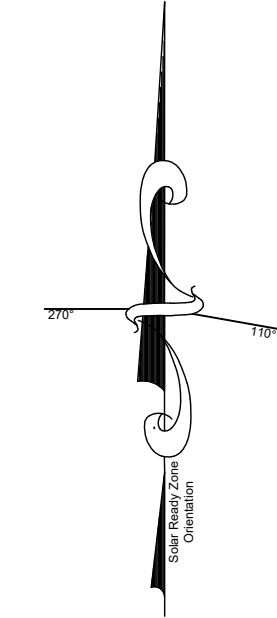

LEGEND

---	PROPERTY LINE
---	ADJACENT PROPERTY LINE
---	EASEMENT
---	CENTERLINE

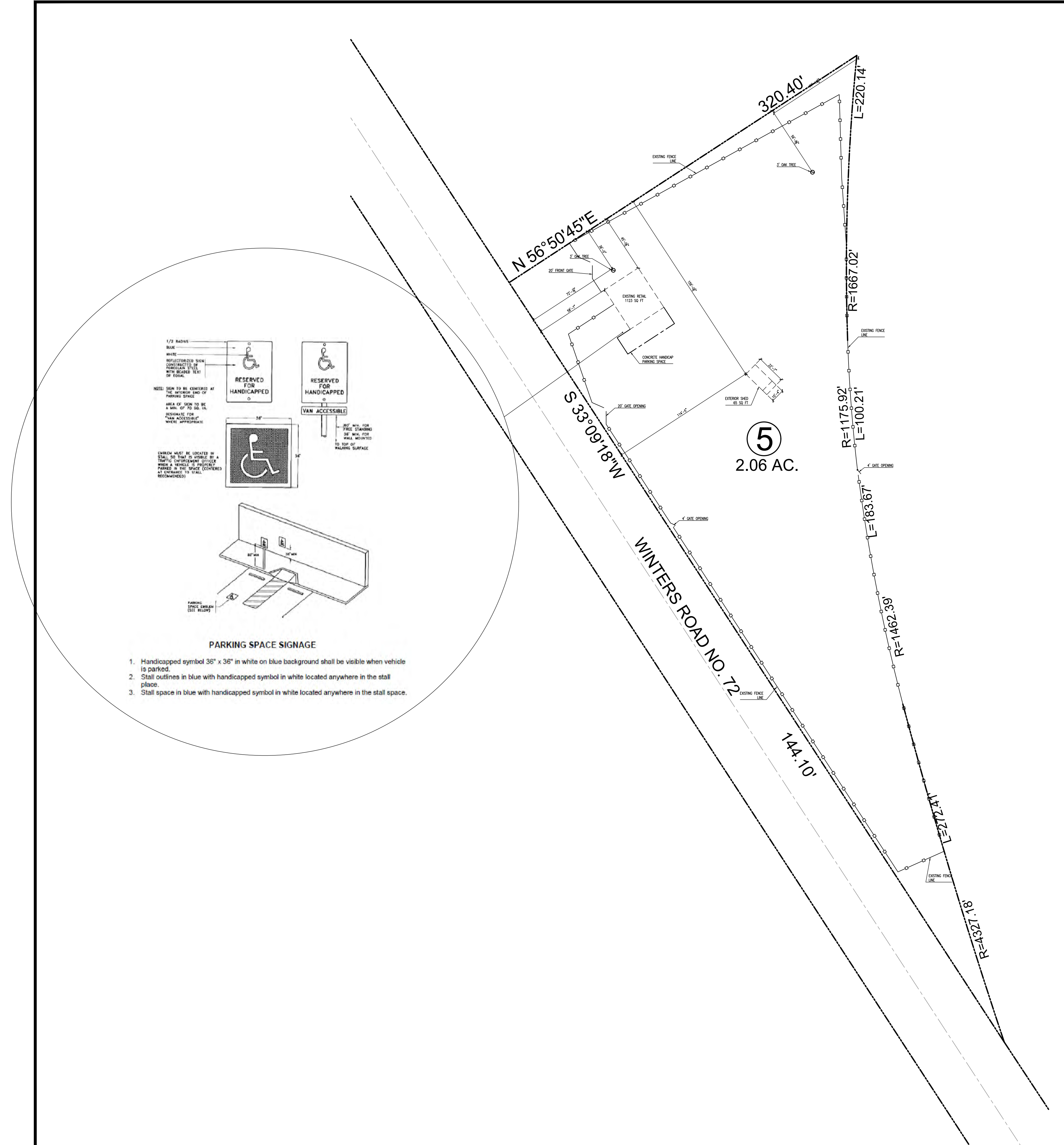

SITE PLAN
SCALE: 1" = 40'-0"

9110 WINTERS RD.
WINTER'S, CA 95694
APN # 0103-160-050

REVISIONS	DESCRIPTION	DATE	NAME
#	Δ		
	Δ		
	Δ		
	Δ		
	Δ		

DESIGNER:
KSM
REVIEWED BY:
KEN
APPROVED BY:

PROJECT #:
24X26

PAGE NAME:
SITE PLAN

PAGE:
AS-1

FLOOR PLAN KEY NOTES

- NOTES: SEE ARCHITECTURAL SYMBOL LEGEND, SHEET AS-1 FOR TYPICAL LAYOUTS AND CONFIGURATIONS
- 1 UTILITY AND SERVICE PANELS.
 - 2 WATER HEATER : GFI SHALL BE PROVIDED FOR THIS UNIT SEE
 - 3 CONCRETE WALKWAY
 - 4 LAVATORY SINK
 - 5 LAVATORY-ROUND FRONT BOWL

9110 WINTERS RD.
WINTER'S, CA 95694
APN # 0103-160-050

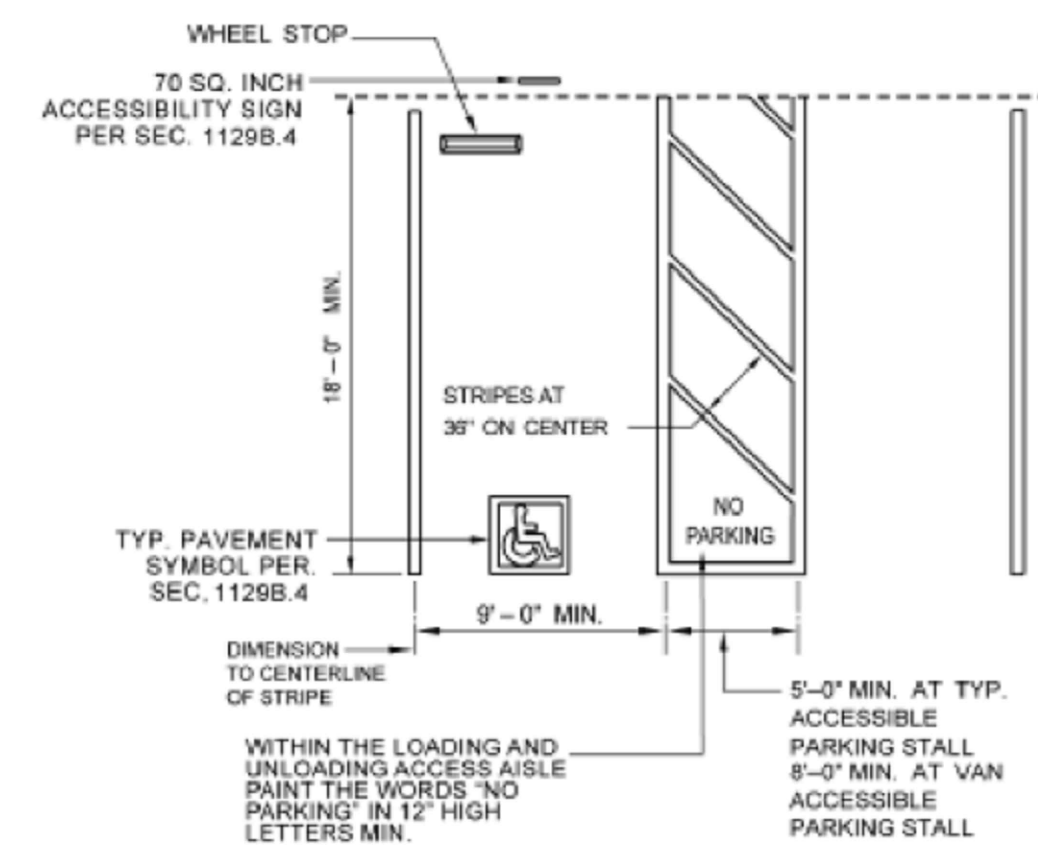
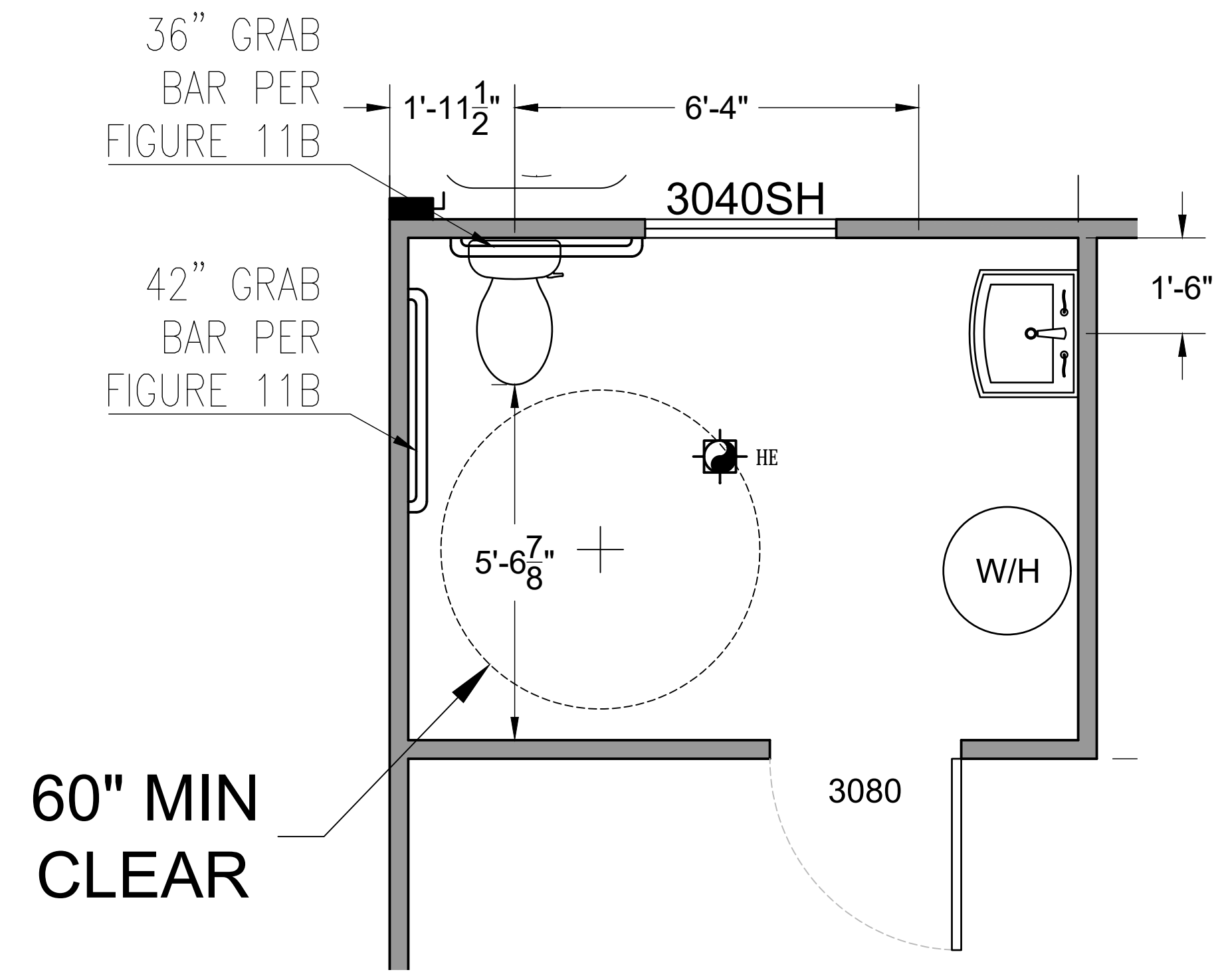
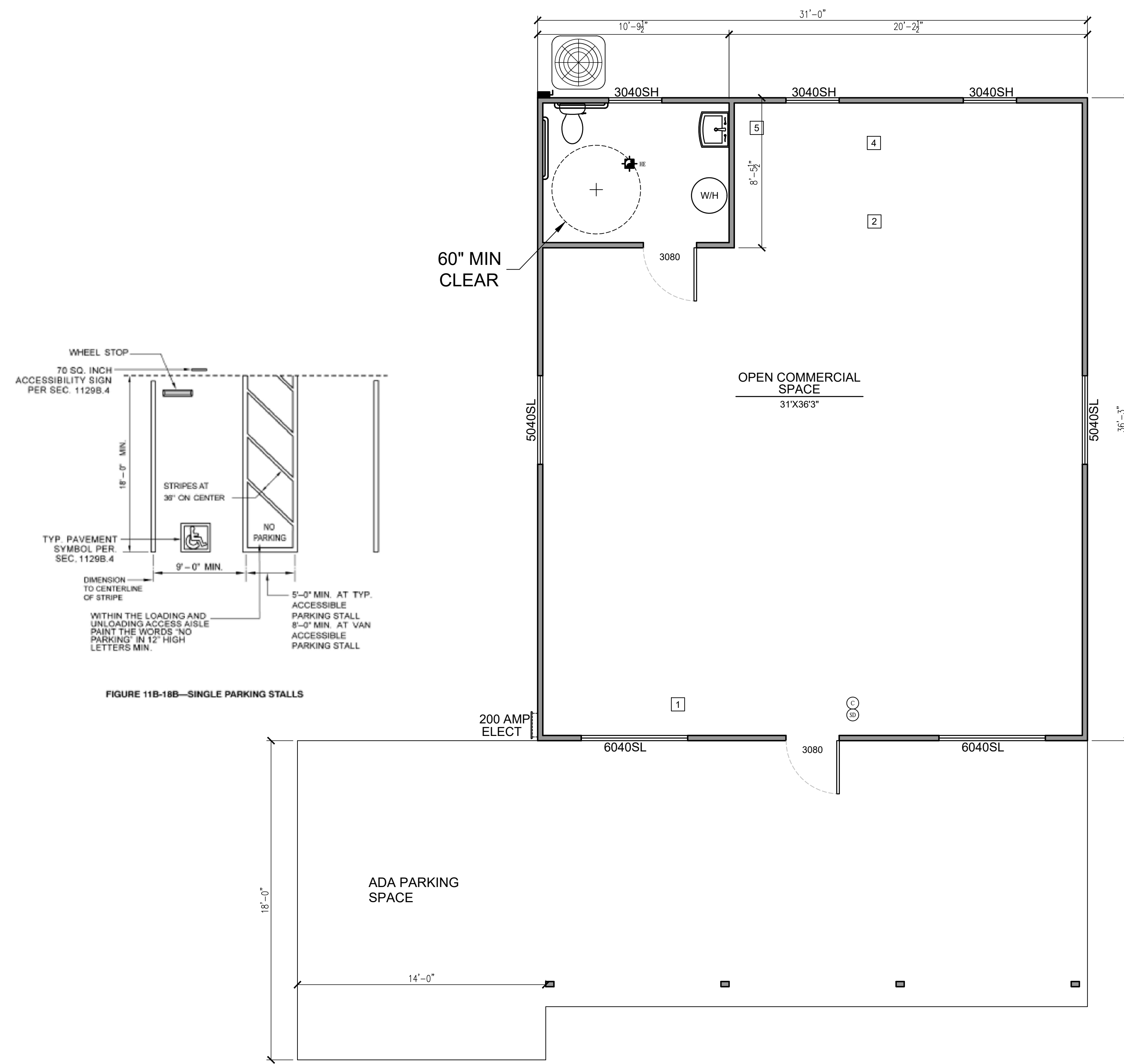
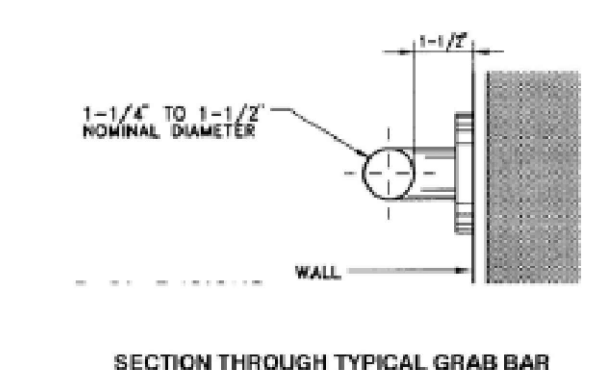

FIGURE 11B-18B—SINGLE PARKING STALLS



SECTION THROUGH TYPICAL GRAB BAR

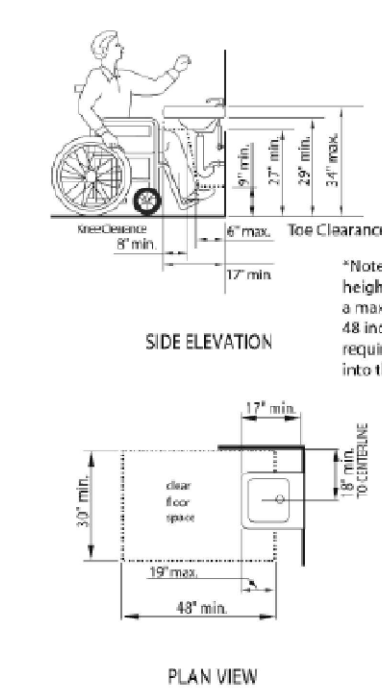

FIGURE 11B-604.7 DISPENSER OUTLET LOCATION

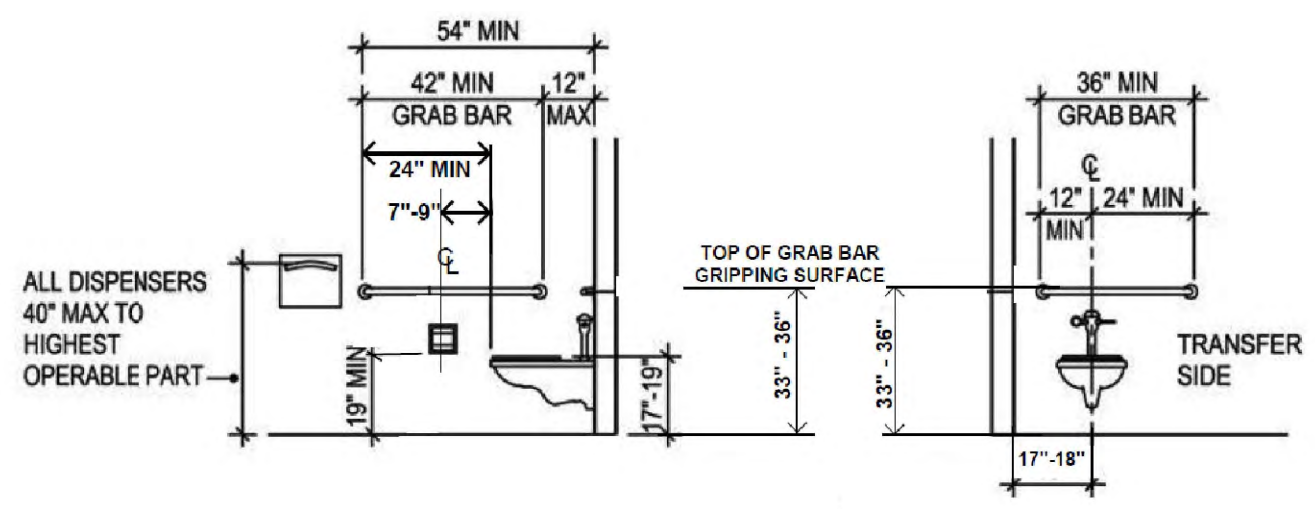

FIGURE 11B-604.5.1 SIDE WALL GRAB BAR AT WATER CLOSETS

FIGURE 11B-604.5.2 REAR WALL GRAB BAR AT WATER CLOSETS

AREA CALCULATIONS	
FLOOR SPACE	
COMMERCIAL SPACE	1123
SHED	65

LEGEND

- 2X4 STUD WALL
- 2X6 STUD WALL
- HALF WALL
- SOFFIT LIMITS
- SHelf ABOVE
- HANDRAIL
- T - TILE FLOOR
- W - WOOD FLOOR
- C - CARPET FLOOR
- V - VINYL FLOOR

FIRST FLOOR PLAN
SCALE: 1/4" = 1'-0"

REVISIONS	DESCRIPTION	DATE	NAME

DESIGNER: KSM
REVIEWED BY: KEN
APPROVED BY:
PROJECT #: 24X26

PAGE NAME:
SPACE PLAN

PAGE:
AS-1

DRAW BY DESIGN

ABBREVIATIONS

A.U.E	ACCESS & UTILITY EASEMENTS	HC	HANDICAP
BSW	BACK OF SIDEWALK	MH	MANHOLE
CO	CLEANOUT	P.U.E	PUBLIC UTILITY EASEMENT
DI	DRAINAGE INLET	SD	STORM DRAIN
DW	DRIVEWAY	SS	SANITARY SEWER
EX	EXISTING	SSCO	SANITARY SEWER CLEANOUT
FL	FLOWLINE	WS	WATER SERVICE

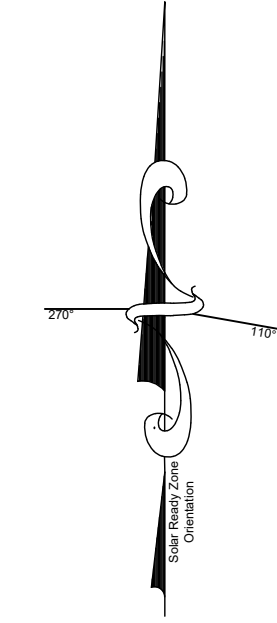

LEGEND

---	PROPERTY LINE
---	ADJACENT PROPERTY LINE
---	EASEMENT
---	CENTERLINE

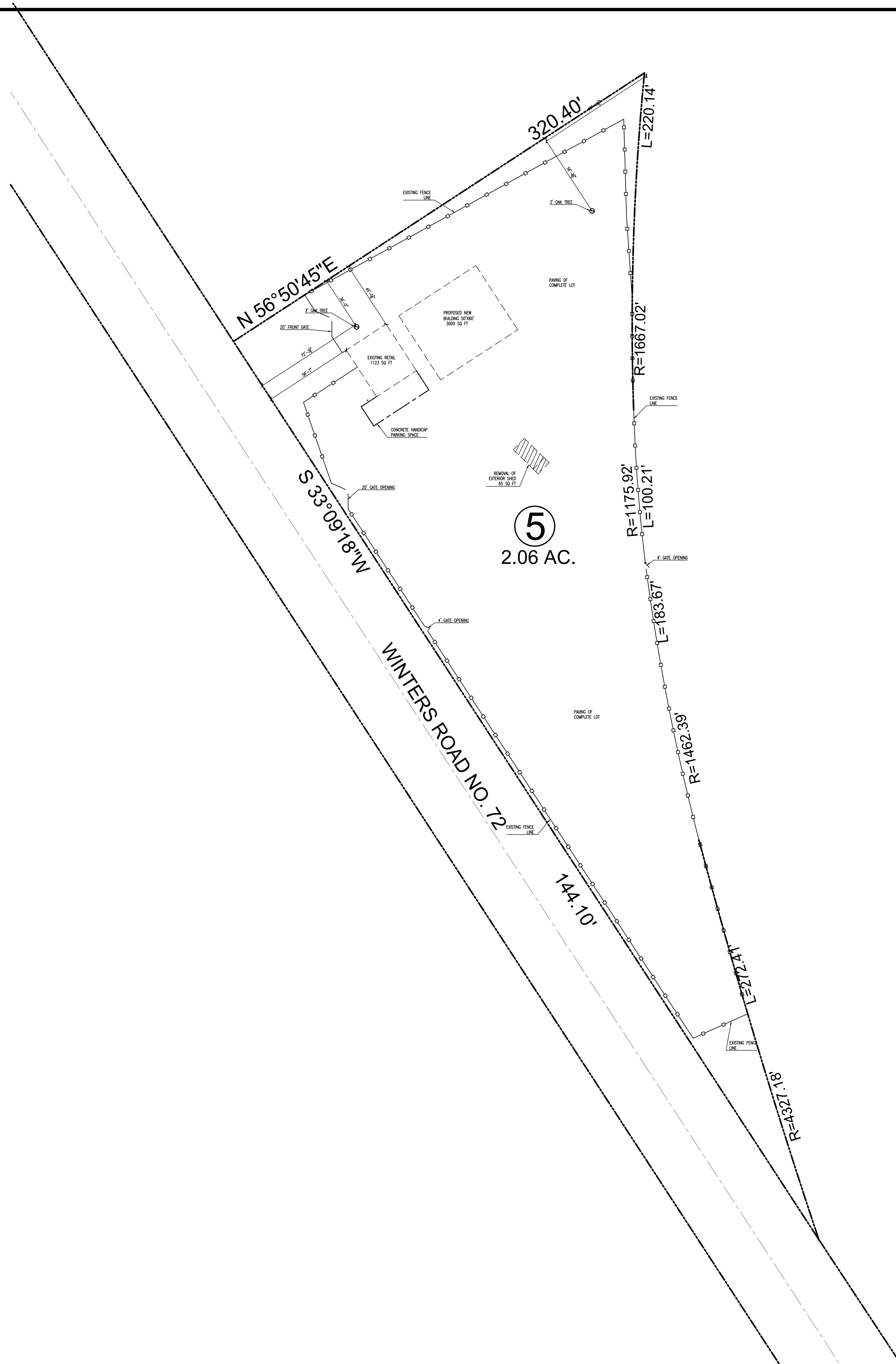

SITE PLAN
SCALE: 1" = 40'-0"

SCOPE OF WORK:
ADD A FUTURE 50'X60' WORK SHOP (3000 SQ FT)
PAVE THE FENCED IN AREA

9110 WINTERS RD.
WINTER'S, CA 95694
APN # 0103-160-050

REVISIONS	DESCRIPTION	DATE	NAME
#	Δ	Δ	Δ

DESIGNER:
KSM
REVIEWED BY:
KEN
APPROVED BY:

PROJECT #:
24X26

PAGE NAME:
FUTURE
SITE PLAN

PAGE:
AS-1.2

9110 Winters Road, APN 0103-160-050

Permit Number	Permit Description	Status
B2006-0141	Replace metal panels with new metal siding	Issued
B2006-0175	New 125 amp panel and lights	Finald
BL2010-0126	Business License for Fremouw Enviromnmental Services	Last renewed 1/31/11