

The following information is provided for guidance to pollworkers and voters regarding operating in-person voting under the current health pandemic.

The goals of this document include:

- Ensuring voters are afforded the right to vote in-person on Election Day;
- Maintaining compliance with local and state health requirements;
- Minimizing the risk of the spread of COVID-19

This document may be updated by the Registrar of Voters during the 60 days leading up to the election to reflect updated health orders, or executive orders within the county or the State of California.

Although the COVID-19 pandemic may be minimized, the following guidelines will still be utilized at all locations to provide a safe voting experience for all voters and minimizing disease spread in closed environments.

This document last updated: September 22, 2022.



Election Day Polling Places:

For All election day poll places, the following minimum actions will be taken per the California Secretary of State Guidelines on reducing the impact of COVID-19. This plan will be implemented by Inspectors at each polling location. Roving inspectors will visit each site to document that the plan is being executed correctly.

Inspectors and Roving inspectors will be provided with an emergency contact list and priority call chain for their specific assigned locations. Additional instructions are provided in their pollworker manual for issues that require escalation.

Part 1: Signage:

All Locations will have clearly posted on the exterior of the polling place all required election signage, plus at least one of the following types of signs:

- Signs outside the polling place indicating the number of persons allowed in the polling place (see Appendix A).
- Signs outside the polling place indicating masks or face coverings are optional for all people entering the facility (see Appendix B).
- Signs inside and outside the polling place reminding voters and observers of physical distancing (See Appendix C).
- Signs outside the polling place reminding voters and observers to use hand sanitizer upon entering (See Appendix D).
- Signs inside the polling place reminding voters to discard secrecy sleeves and pens, and to place their own ballot in the ballot box (see Appendix E).
- Signs inside the polling place reminding voters and observers to use hand sanitizer upon exiting the polling place (See Appendix F).
- Placing the “Curbside Voting” cone and sign in an easy to see location for the most number of voters (see Appendix G).

An example of proper signage placement is shown on the next page.



Example of minimum COVID-19 prevention signs and floor markings at polling places. In some cases, signs may include multiple messages and may be placed at multiple locations:

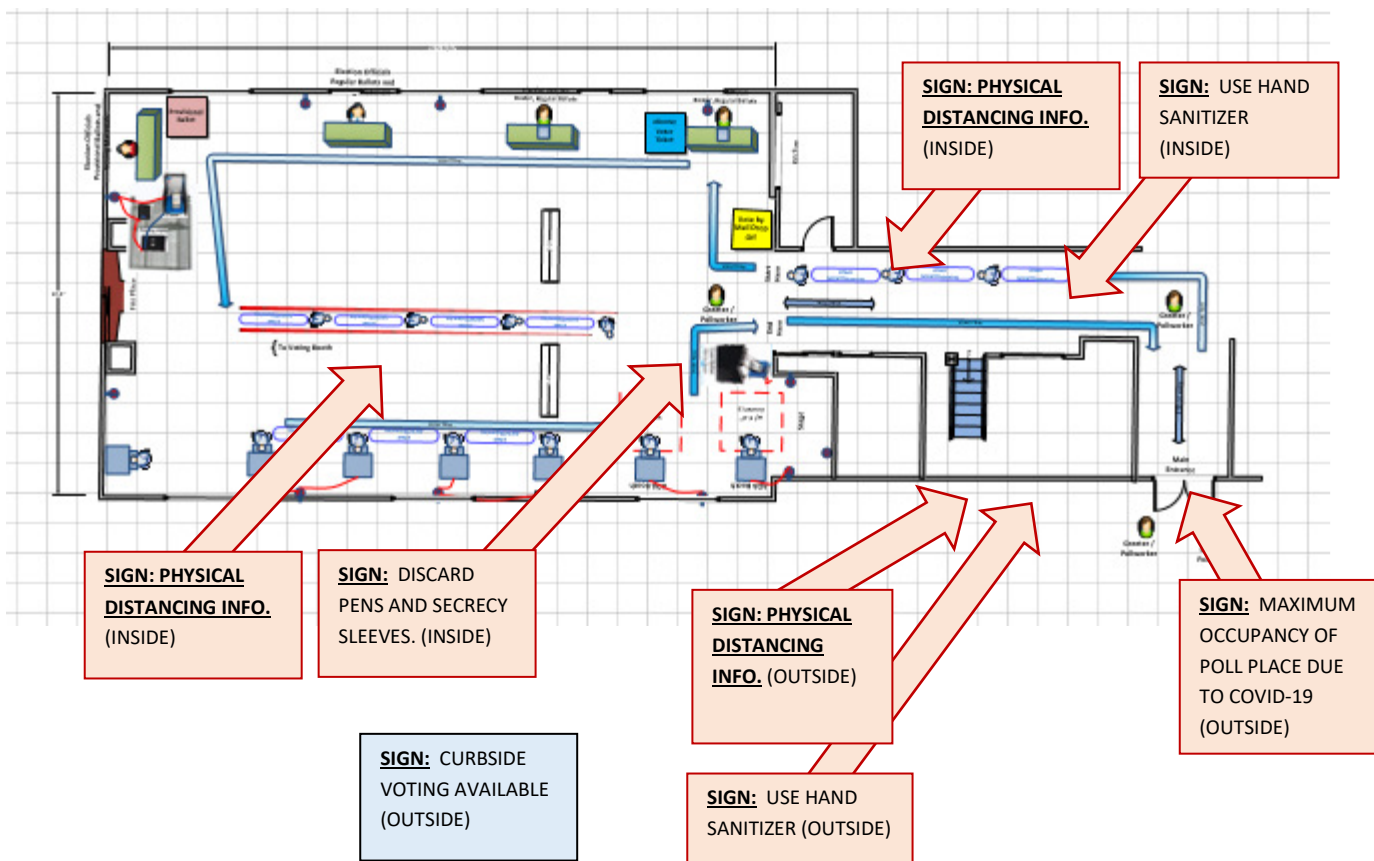



Part 2: Protective Equipment:

All pollworkers will be provided with a plastic face shield, a supply of disposable face masks, a supply of disposable gloves, 10 containers of hand sanitizer, and at least 5 containers of disinfecting wipes. Additional supplies can be provided by roving inspectors, or by contacting the ROV.

All pollworkers are trained to be respectful of people regarding their personal face covering choices.

Pollworkers shall follow the instructions from their pollworker training on how to properly wear/replace/dispose of face coverings, how to properly wear/use/remove gloves, how to properly/frequently use hand sanitizer, and how to properly/frequently clean voting touch points. Links to training videos are found in Appendix H.

Pollworkers should avoid sharing equipment and supplies to the extent possible.

Part 3: Training of staff working each location:

All pollworkers have been trained prior to working the location on methods to minimize COVID-19. Each worker shall verify on the inspector check-list that they have completed the following courses:

- Basic COVID-19 information;
- Proper use of PPE equipment;
- Proper signage to deploy and setup at a polling place;
- Processing voters and maintaining social distancing at a poll place;
- De-Escalation techniques for voters without masks;
- How to administer this workplace plan.

Inspectors shall maintain a checklist indicating verbally from each pollworker that they have taken the classes mentioned above and if not, will provide copies of training slides in Appendix H.

Part 4: Traffic Flow and Physical Distancing:

All locations will have a custom layout for voting (Appendix I) based on the model layout shown below. Specific goals of each layout are identified below:

- Stations and booths should be placed in a manner to create physical distancing between check-in stations, voting booths, ballot boxes and queueing spaces.
- Work towards ensuring voting booths provide privacy of voters.



- Where possible designate and use separate entry/exit points.
- Setup and support options to drop-off vote by mail ballot outside or as close to the entrance of the voting space as possible.
- Doors and windows shall be propped open to the extent possible during the voting period to allow for fresh-air flow.
- Locations with a single point of entry/exit will have additional pollworkers stationed to monitor the flow of people to ensure voters do not pass each other upon entering/exiting.
- All locations will have visual cues on the floor with either signs or tap to indicate traffic flow, staging areas, and where to stand for proper social distancing.

Inspectors of each location shall verify all signage is placed correctly.

Roving inspectors shall verify that the layout is adhered to throughout their visits.

Part 5: Cleaning, Disinfecting and Ventilation:

As mentioned in part 2, all voters and pollworkers will be afforded protective equipment and documentation on how to use such equipment. Additionally, disinfecting wipes are provided for cleaning “touch points” throughout the day. These locations include: doors, door frames, tables, chairs, voting booths, check-in stations, and ballot scanners.

All possible touch points should be cleaned as often as possible, rotating voters to clean stations while stations are being cleaned and/or disinfected.

Pens provided to voters should be discarded or taken with the voter at the end of voting. Additionally, secrecy sleeves for this election are disposable and should not be re-cycled between voters.

Equipment Specific Instructions:

Electronic Rosters: The Electronic rosters and components used by Solano County should not be touched by voters or observers. In the event these devices are used/touched by voters, these guidelines should be applied:

- Use Disinfecting wipes provided by ROV to gently clean/wipe the stylus, printer and ipad screen. Be careful not to get moisture in any openings on the ipad or printer.
- Clean between voters only if voter has touched any component.
- Clean if changing pollworkers.



Ballot Scanner: Surfaces of the Hart Ballot Scanner can be wiped down with a 70% Clear isopropyl alcohol, 30% water based solution. These wipes have been provided by the ROV and provided to each equipment clerk and roving inspector. The ballot scanner should be wiped down between EACH voter if possible.

Touch Writer / Ballot on Demand: Surfaces of the Hart TouchWriter and Ballot on demand system can be wiped down with a 70% Clear isopropyl alcohol, 30% water based solution. These wipes have been provided by the ROV and provided to each equipment clerk and roving inspector. The ballot scanner should be wiped down between EACH voter if possible.

Voters using the touch-writer should use a personal stylus or disposable stylus provided by the ROV.

Voting Booths: All plastic voting booths can be wiped down with standard Clorox disinfecting wipes or similar. These wipes shall be provided by the ROV, and used between voters on all voting booths used. Voters shall be directed to a “clean” voting booth while the “used” voting booths are being sanitized.

All locations shall be professionally cleaned/sanitized at the close of voting in respect to the use of the polling location and before any equipment is returned to the ROV.

Part 6: Voters and observers who refuse Face Coverings:

All voters are allowed to vote and should never be turned away. This plan, and instructions provided to pollworkers are provided to minimize risk.

Face coverings for voters are optional and should not be required by pollworkers.

Pollworkers can provide alternative forms of voting to help provide a safe experience for all. This includes:

- Voters may choose to vote from their vehicle as a curbside voter.
- Voters may choose to vote inside when the pollworkers ensure all voters have safe distancing away from voters without face coverings.

In light of this, the inspector administering the plan, should evaluate the physical space and be prepared to identify methods for isolating this voter from others at the following locations. Some locations are significantly large enough to create safe distancing from other voters. Alternatively, some locations are very small, and may require voters waiting to “take turns” to vote. In those cases, the inspector of the polling place should review the following touch points to identify ways to provide proper distancing:



- If a line to check-in exists, can a pollworker “hold their spot” in line until appropriate?
- At Check-in – what space is available leading up to the check-in point and where will the voter queue once check-in is complete. Can check-in be completed while waiting in line?
- Determine a specific voting booth for the voter that may have further distancing from other booths. Notify voter of the estimated processing time.
- When casting the ballot, take measures to ensure a minimum of 6’-0” is provided from other voters and pollworkers.

Pollworkers and inspectors should refer to their training on de-escalation methods to ensure a peaceful and calm voting process is maintained for all voters and pollworkers.

Observers shall not be required to wear face coverings while inside a polling place. An inspector may use their judgement in determining if social distances are being maintained by observers and ask them to leave, or provide enough space for safety..

Part 7: Curbside Voting

All voters will be allowed to vote “curbside” at any voting location and the ROV has advertised this as a “limited contact” method vs. casting a ballot inside a polling place. Pollworkers have been trained specifically on how to cast a ballot by this method. However, pollworkers should take the following precautions on-site to minimize risk:

- Wear gloves provided by ROV before assembling materials to be brought outside;
- Bring hand-sanitizer for the voter to use before and after voting;
- In addition to wearing a mask, pollworkers should consider wearing a face-shield in the event the voter isn’t wearing a mask.
- Maintain physical distancing to the extent possible by approaching only for necessary handoff of materials.
- Remember to hand voter an I-Voted sticker.



Appendix A – Sign: Maximum Occupancy – 8.5 X 11

Do Your Part to Prevent COVID-19!

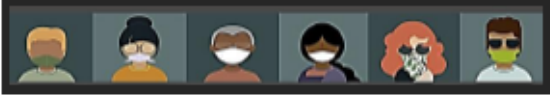

✓ **MAINTAIN YOUR SPACE – 6 feet**

✓ **COVER YOUR FACE**

POLL PLACE NAME

MAXIMUM CAPACITY

PERSONS



**UPON ENTERING
PLEASE USE
HAND SANITIZER**

**HELP STOP THE
SPREAD OF COVID-19**





Appendix B – Sign: Face Coverings Information (8.5” x11”):

- **Not used for 2022 elections.**



Appendix C – Sign: Physical Distancing – 8.5 x 11

Please wear a cloth face covering.

6 ft

Maintain a distance of 6 feet whenever possible.



cdc.gov/coronavirus

CS 21/7/18-8 05/27/2020

The sign features a green header with the text 'Please wear a cloth face covering.' Below this is a large illustration of a woman with dark hair in a bun, wearing a yellow headband and a pink floral cloth face mask. To the left, a circular inset shows two people standing 6 feet apart, with a double-headed arrow and '6 ft' text between them. The background includes faint blue virus icons. At the bottom left is the CDC logo, and at the bottom right is the URL 'cdc.gov/coronavirus' on a yellow background. A small version number 'CS 21/7/18-8 05/27/2020' is in the bottom left corner.



Appendix D – Sign: Use Hand Sanitizer upon Entry – 8.5” x 11”





Appendix E – Sign: Discard Pens and Secrecy Sleeves

Do Your Part to Prevent COVID-19!



- ✓ **MAINTAIN YOUR SPACE – 6 feet**
- ✓ **COVER YOUR FACE**

**PLEASE DISPOSE OF PENS
AND SECRECY SLEEVES.**





Appendix F – Sign: Use Hand Sanitizer upon Exit



Solano County Registrar of Voters – Workshop for Polling Place Operations – 01/03/2022



Appendix G – Curbside Voting Cone (placed outside)



Solano County Registrar of Voters – Workplan for Polling Place Operations – eff. 09/2022



Appendix H – COVID Pollworker Training Slides

COVID Overview for Voters –

<https://www.youtube.com/watch?v=u98CR3wT0Fg>

COVID Overview for Pollworkers –

<https://admin.solanocounty.com:4433/media/narratedcovidppt.mp4>

Setting up a polling place -

<https://admin.solanocounty.com:4433/media/COVIDpollplacesetupVO.mp4>

The Election Day Experience –

<https://admin.solanocounty.com:4433/media/PPEinstructions.mp4>



Appendix I – Custom Layouts for Each Poll Place

COVID-19 Prevention Action Plan – Poll Places



Rio Vista – 45 Main St. Center:



9x Social Distance Markers

MAXIMUM OCCUPANCY:
15

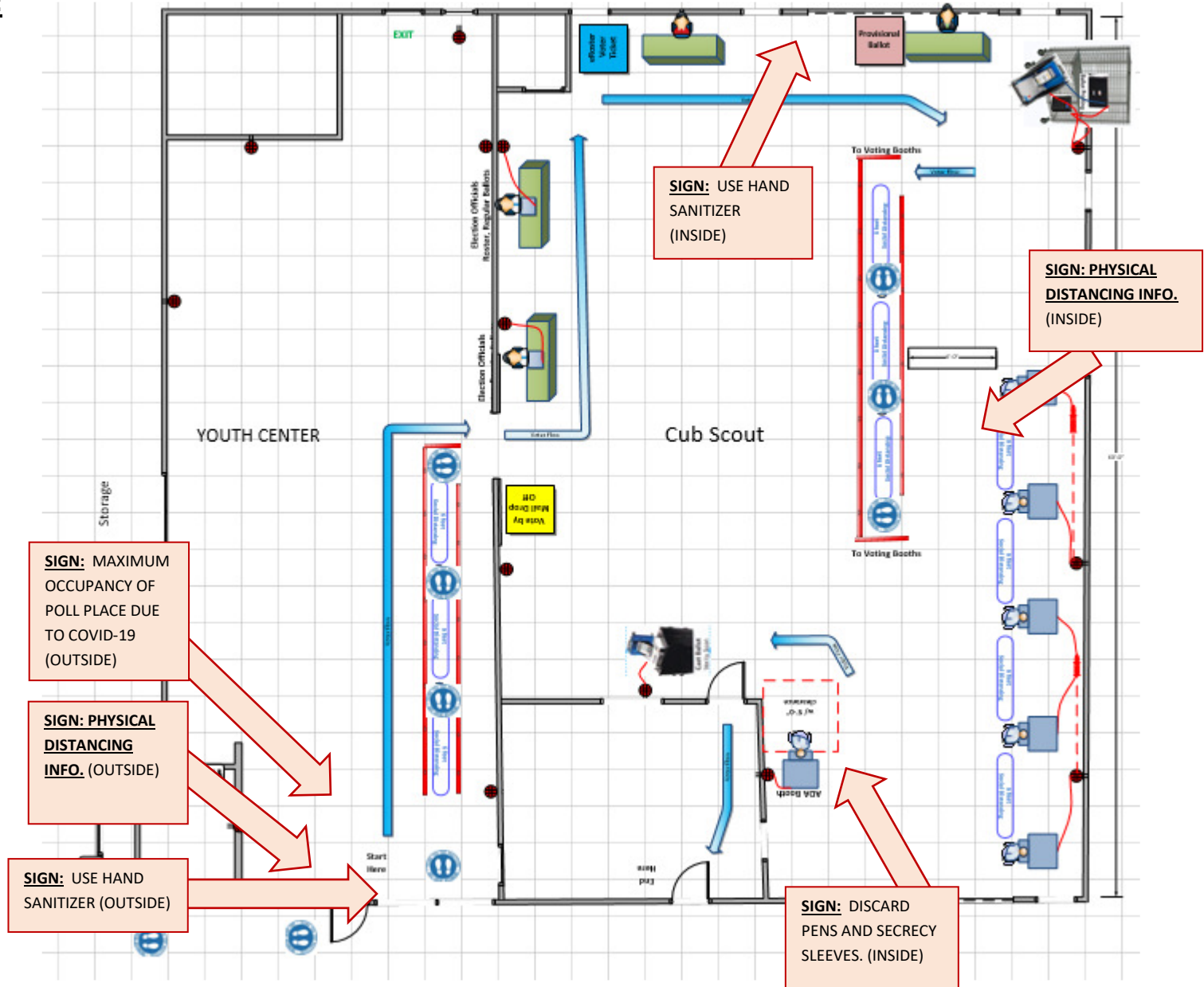

COVID-19 Prevention Action Plan – Poll Places



Rio Vista – Trilogy:



10x Social Distance Markers

SIGN (outside):
 1) MAXIMUM OCCUPANCY;
 2) USE HAND SANITIZER;
 3) PHYSICAL DISTANCING INFO;

**MAXIMUM OCCUPANCY:
 15**

SIGN: CURBSIDE VOTING AVAILABLE (OUTSIDE)

SIGN: DISCARD PENS AND SECRECY SLEEVES. (INSIDE)

SIGN: PHYSICAL DISTANCING INFO. (INSIDE)

SIGN: USE HAND SANITIZER (INSIDE)

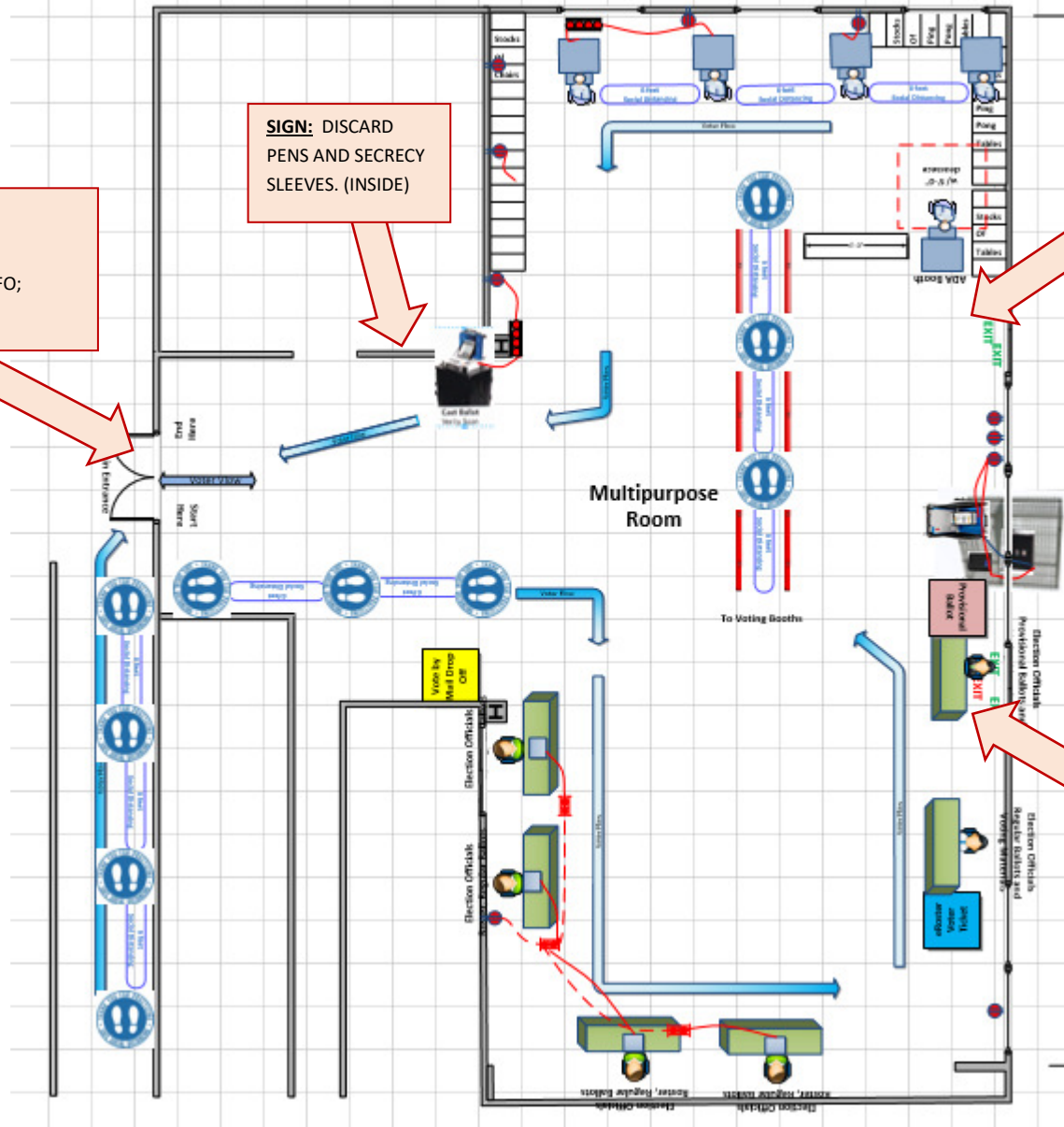

COVID-19 Prevention Action Plan – Poll Places



Dixon – C.A. Jacobs Middle School:



4x Social Distance Markers

MAXIMUM OCCUPANCY:
10

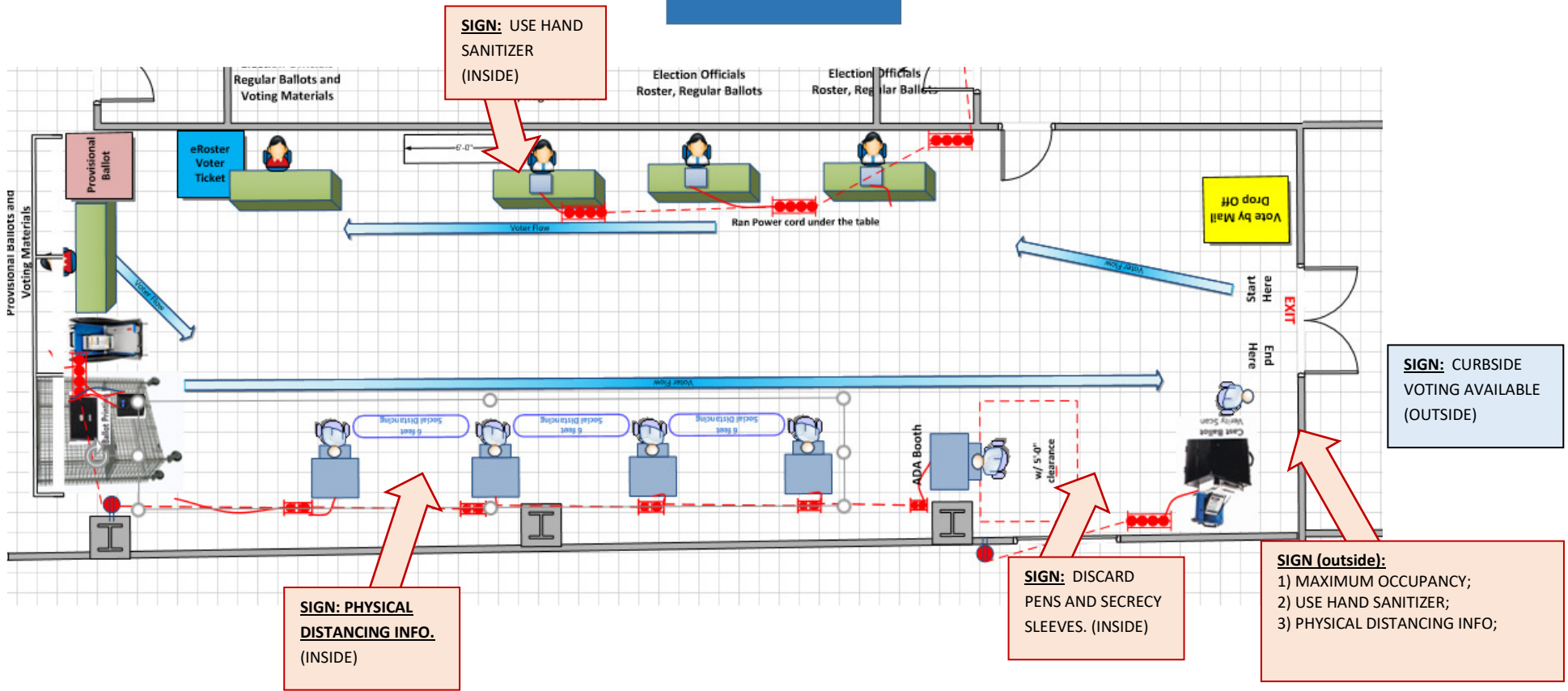

COVID-19 Prevention Action Plan – Poll Places



Dixon – Dixon Senior center:



12x Social Distance Markers

MAXIMUM OCCUPANCY: 15

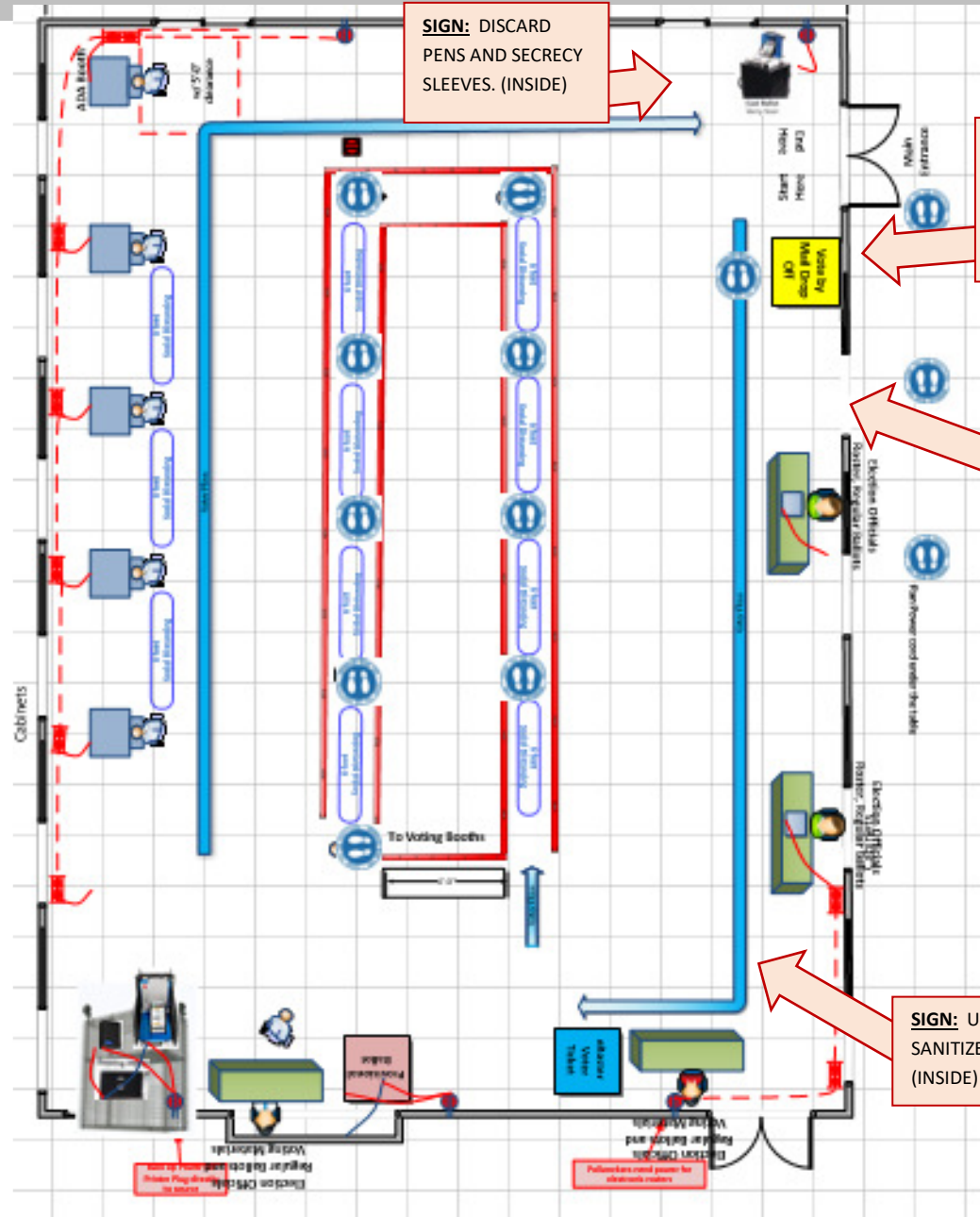

SIGN: DISCARD PENS AND SECRECY SLEEVES. (INSIDE)

SIGN (outside):
 1) MAXIMUM OCCUPANCY;
 2) USE HAND SANITIZER;
 3) PHYSICAL DISTANCING INFO;

SIGN: CURBSIDE VOTING AVAILABLE (OUTSIDE)

SIGN: PHYSICAL DISTANCING INFO. (INSIDE)

SIGN: USE HAND SANITIZER (INSIDE)

COVID-19 Prevention Action Plan – Poll Places



Dixon – Veterans



6x Social Distance Markers

MAXIMUM OCCUPANCY:
15

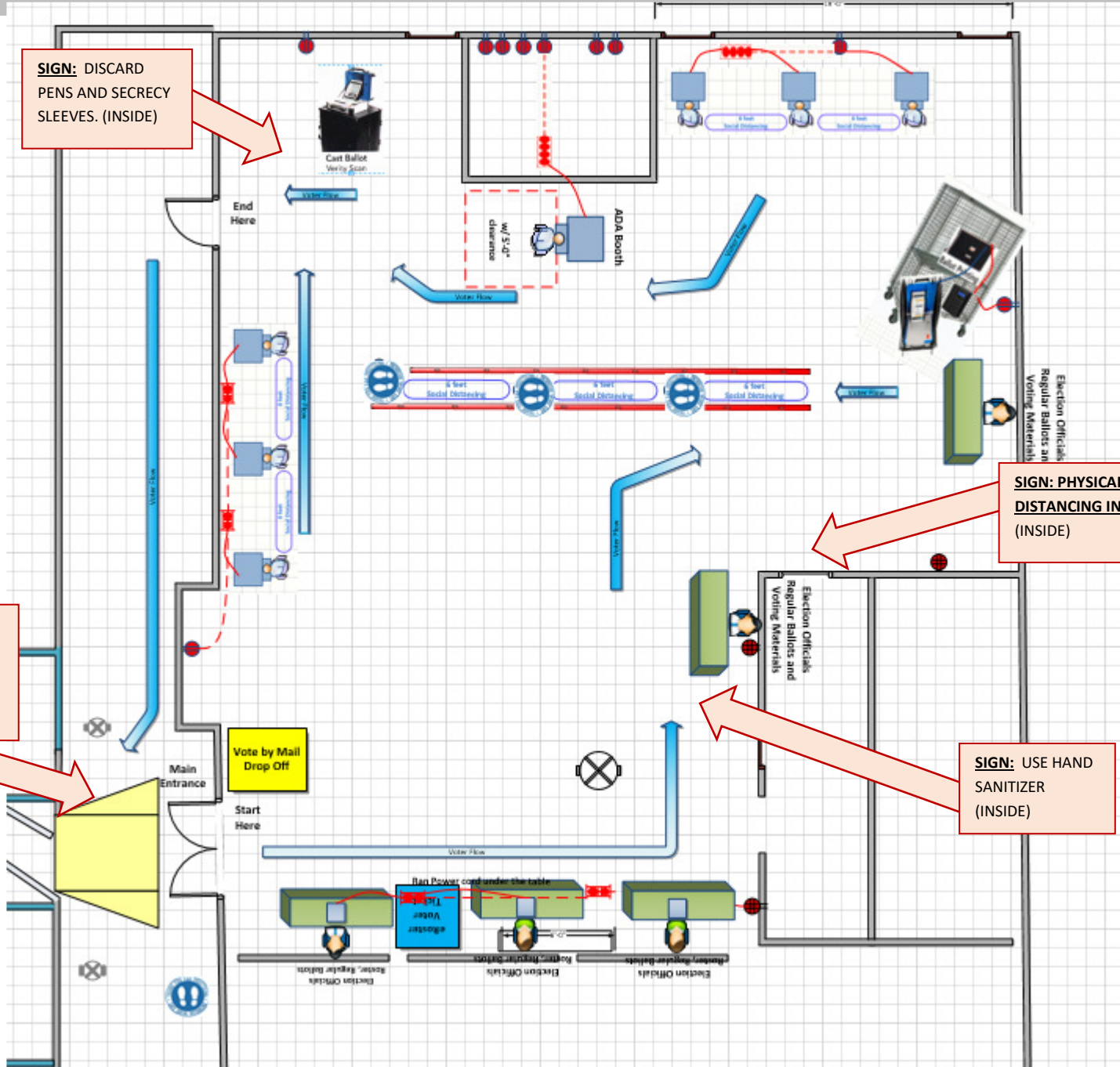

COVID-19 Prevention Action Plan – Poll Places



Benicia – Benicia Senior Center



13x Social Distance Ma

SIGN: CURBSIDE VOTING AVAILABLE (OUTSIDE)

SIGN (outside):
 1) MAXIMUM OCCUPANCY;
 2) USE HAND SANITIZER;
 3) PHYSICAL DISTANCING INFO;

SIGN: PHYSICAL DISTANCING INFO. (INSIDE)

SIGN: DISCARD PENS AND SECRECY SLEEVES. (INSIDE)

SIGN: USE HAND SANITIZER (INSIDE)

MAXIMUM OCCUPANCY: 15

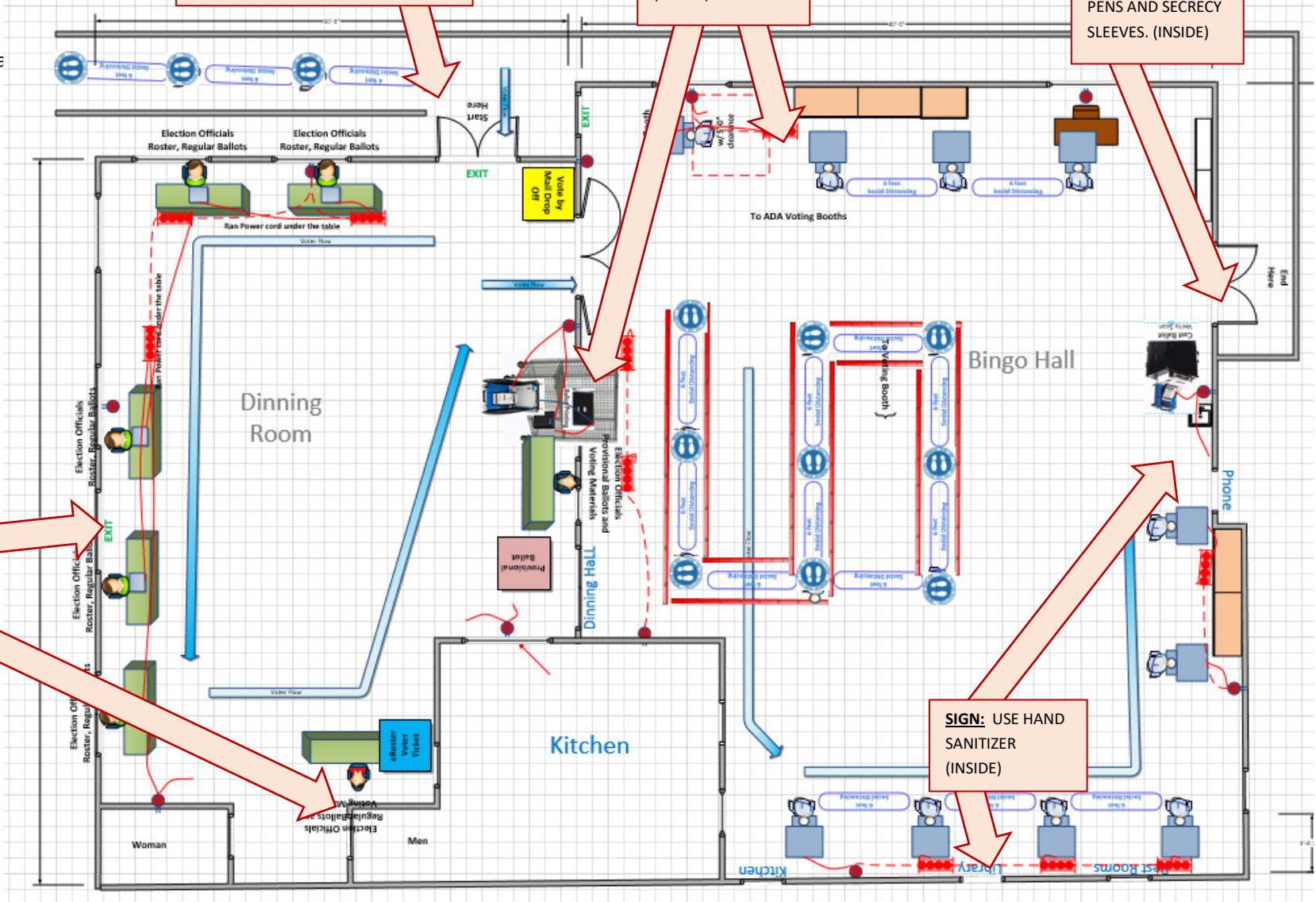

COVID-19 Prevention Action Plan – Poll Places



Benicia – Lighthouse

MAXIMUM OCCUPANCY: 20

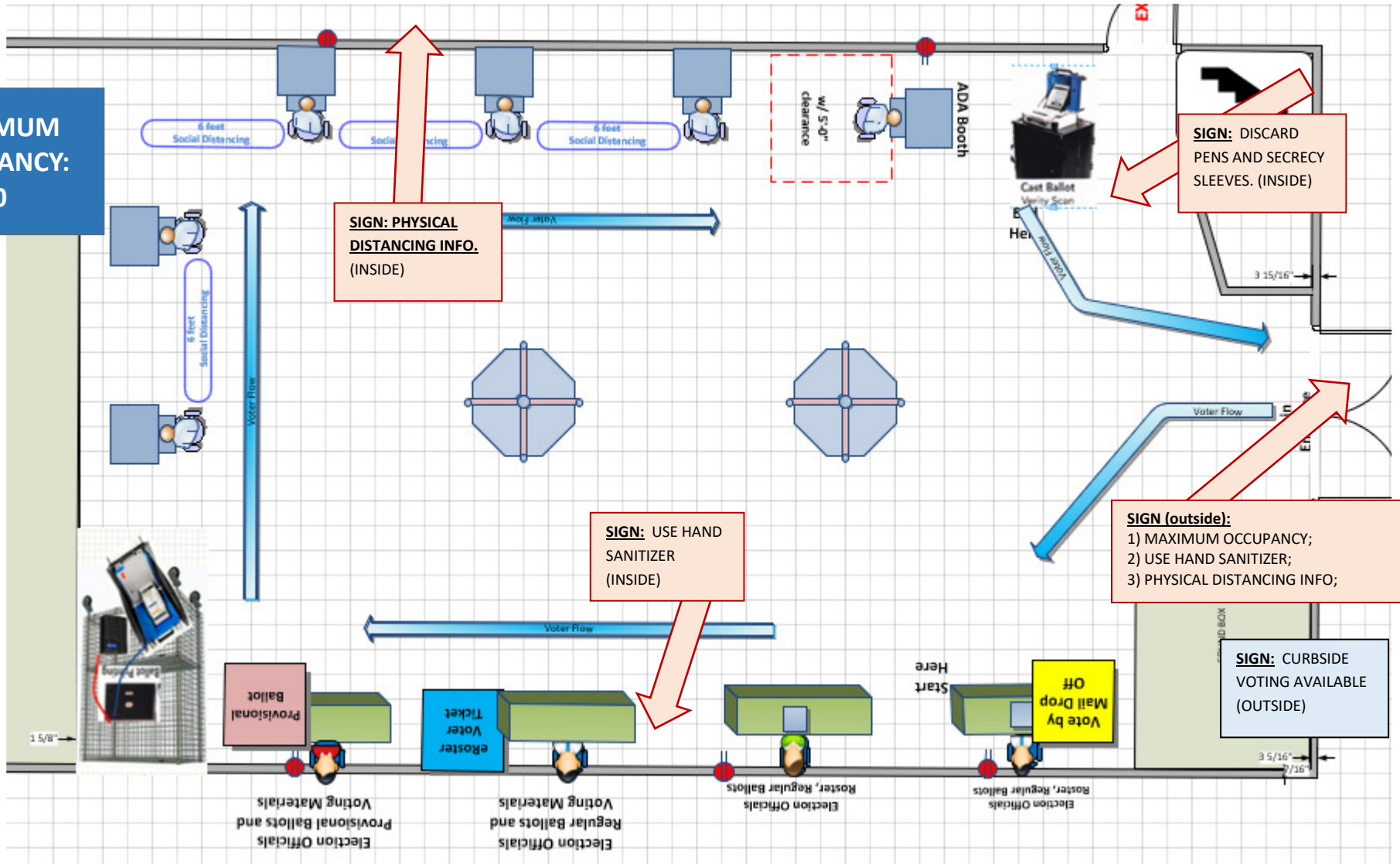

COVID-19 Prevention Action Plan – Poll Places



Benicia – Turner Elementary



6x Social Distance Markers

MAXIMUM OCCUPANCY:
5

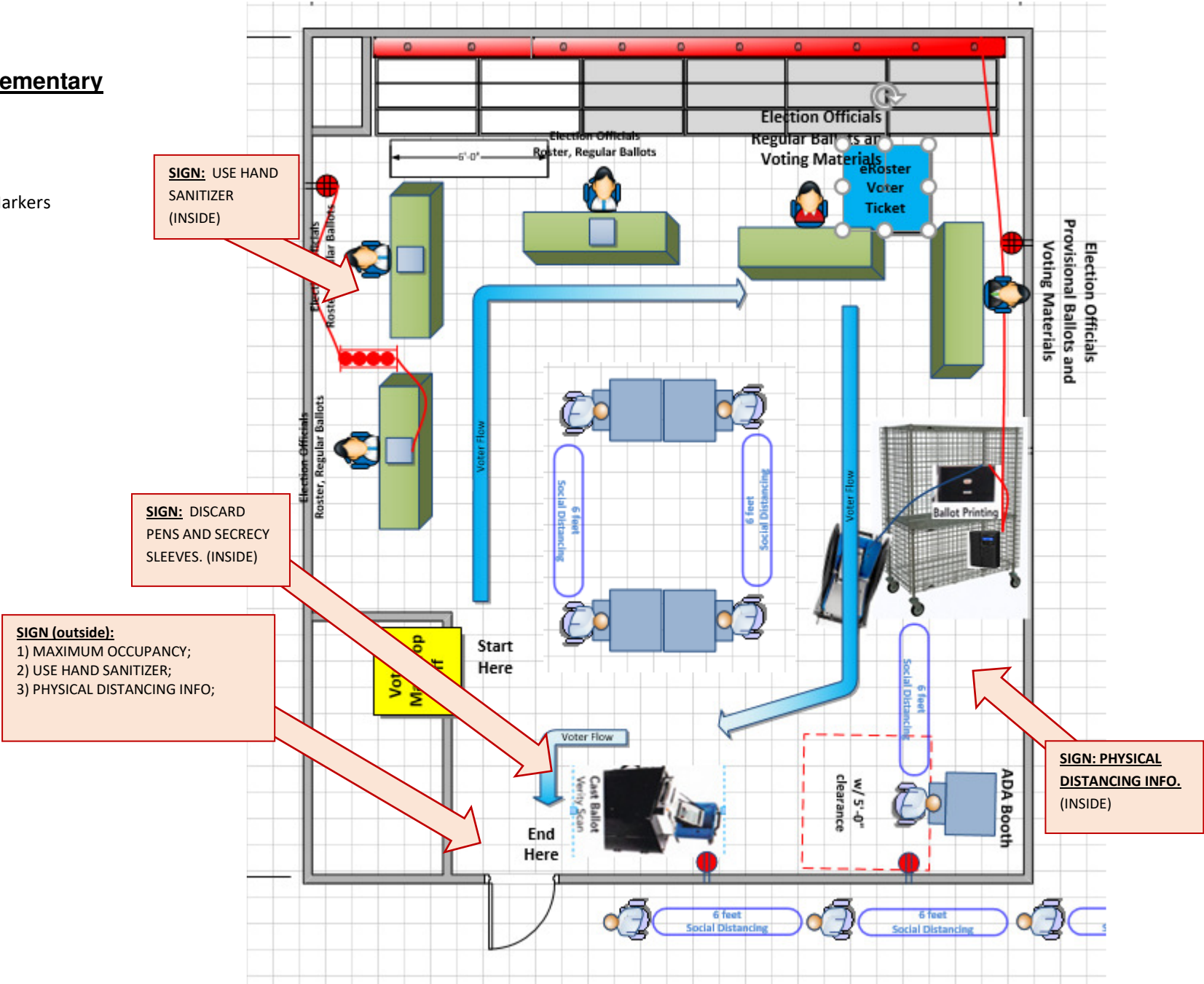

COVID-19 Prevention Action Plan – Poll Places



Benicia – Church of Christ LDS



8x Social Distance Markers

SIGN: CURBSIDE VOTING AVAILABLE (OUTSIDE)

SIGN (outside):
 1) MAXIMUM OCCUPANCY;
 2) USE HAND SANITIZER;
 3) PHYSICAL DISTANCING INFO;

SIGN: CURBSIDE VOTING AVAILABLE (OUTSIDE)

MAXIMUM OCCUPANCY:
 15

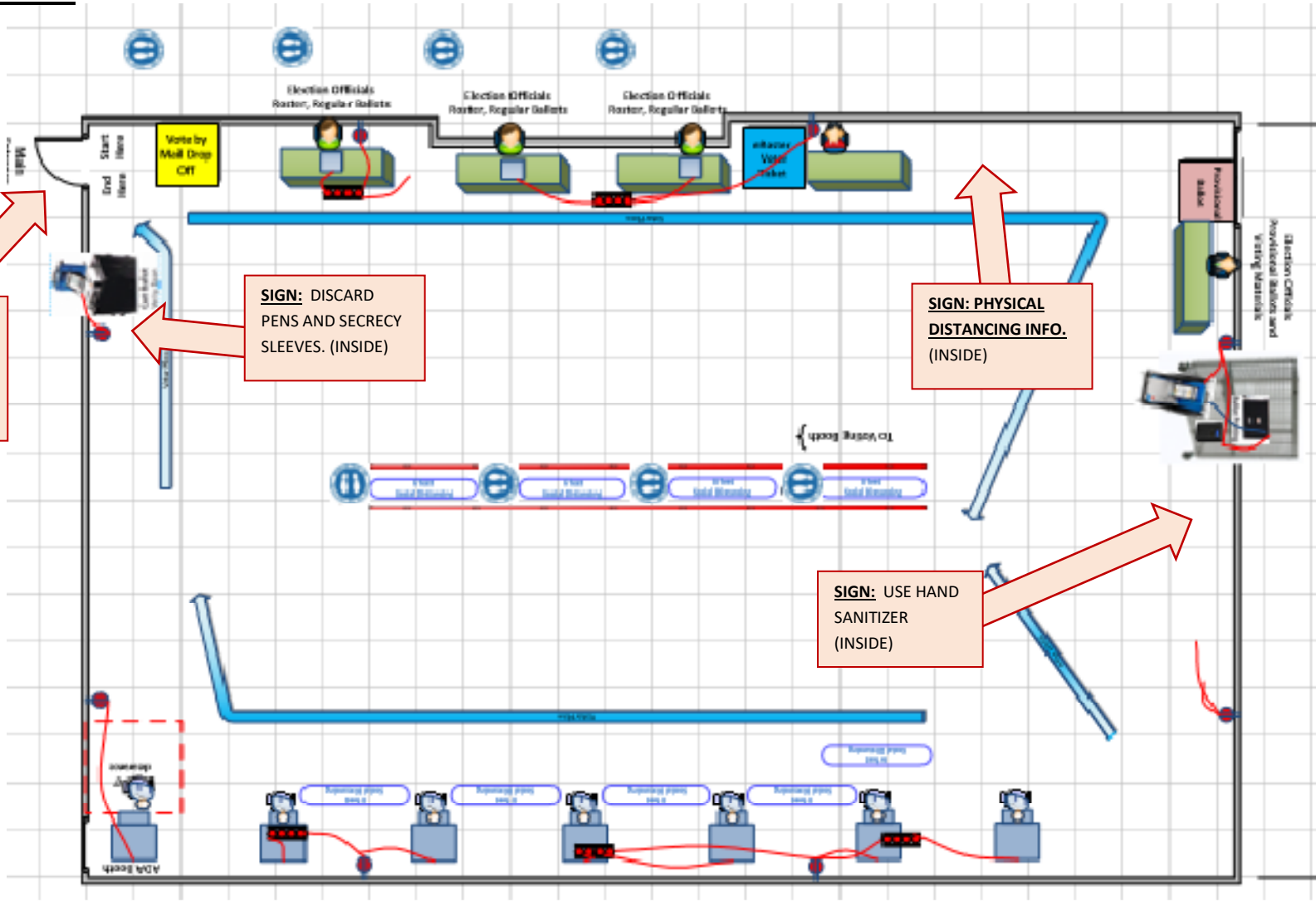

COVID-19 Prevention Action Plan – Poll Places



Benicia – California National Guard Armory:



23x Social Distance Markers

MAXIMUM OCCUPANCY:
25

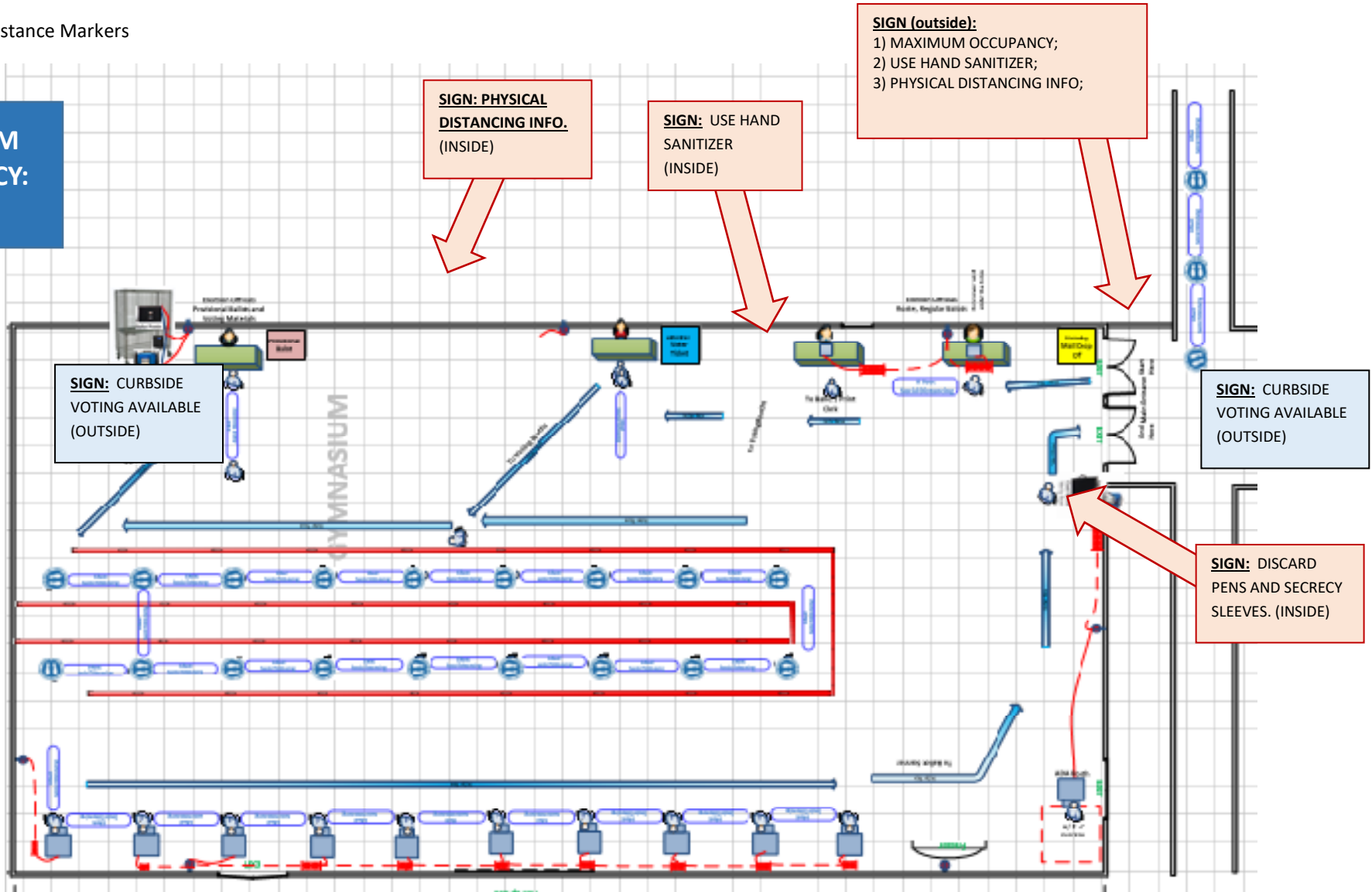

COVID-19 Prevention Action Plan – Poll Places



Suisun City – Nelson Community Center



8x Social Distance Markers

MAXIMUM OCCUPANCY:
15

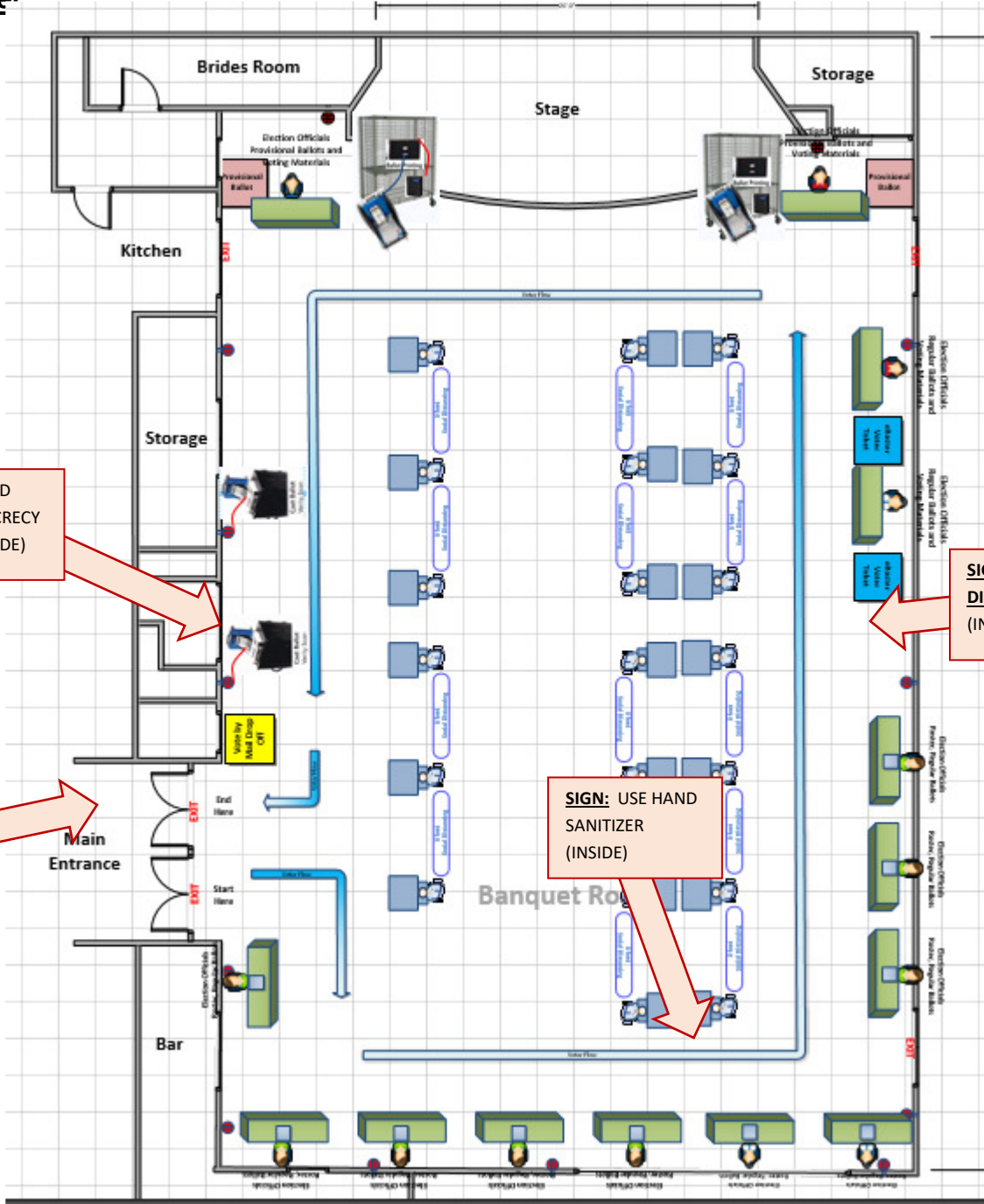

SIGN: DISCARD PENS AND SECRECY SLEEVES. (INSIDE)

SIGN: PHYSICAL DISTANCING INFO. (INSIDE)

SIGN (outside):
1) MAXIMUM OCCUPANCY;
2) USE HAND SANITIZER;
3) PHYSICAL DISTANCING INFO;

SIGN: USE HAND SANITIZER (INSIDE)

SIGN: CURBSIDE VOTING AVAILABLE (OUTSIDE)

COVID-19 Prevention Action Plan – Poll Places



Suisun City – City Hall:



8x Social Distance Markers

SIGN (outside):
 1) MAXIMUM OCCUPANCY;
 2) USE HAND SANITIZER;
 3) PHYSICAL DISTANCING INFO;

SIGN: CURBSIDE VOTING AVAILABLE (OUTSIDE)

MAXIMUM OCCUPANCY:
 10

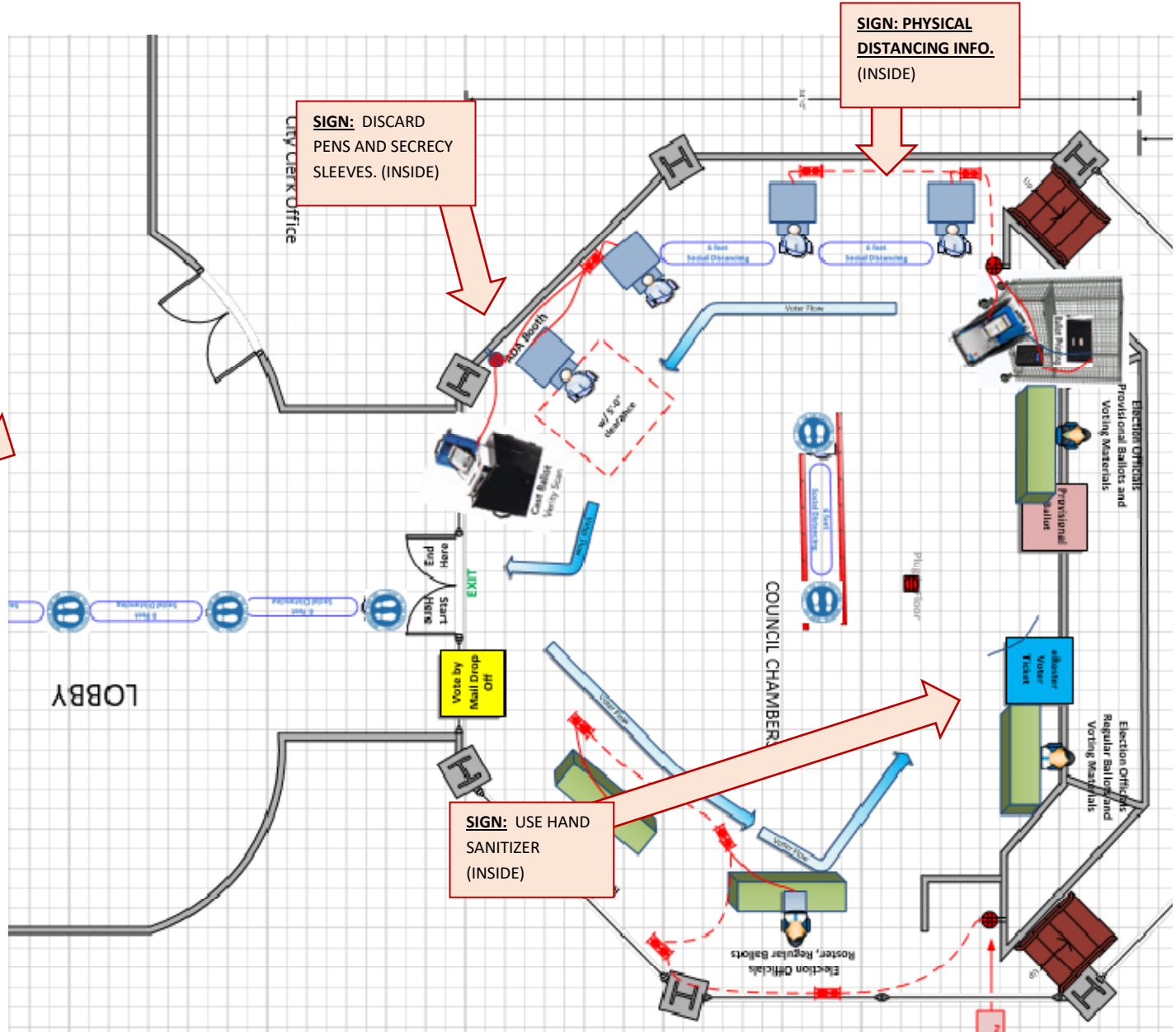

COVID-19 Prevention Action Plan – Poll Places



Suisun City – In-Shape



8x Social Distance Mats

SIGN (outside):
 1) MAXIMUM OCCUPANCY;
 2) USE HAND SANITIZER;
 3) PHYSICAL DISTANCING INFO;

SIGN: CURBSIDE VOTING AVAILABLE (OUTSIDE)

SIGN: DISCARD PENS AND SECRECY SLEEVES. (INSIDE)

SIGN: USE HAND SANITIZER (INSIDE)

SIGN: PHYSICAL DISTANCING INFO. (INSIDE)

MAXIMUM OCCUPANCY: 25

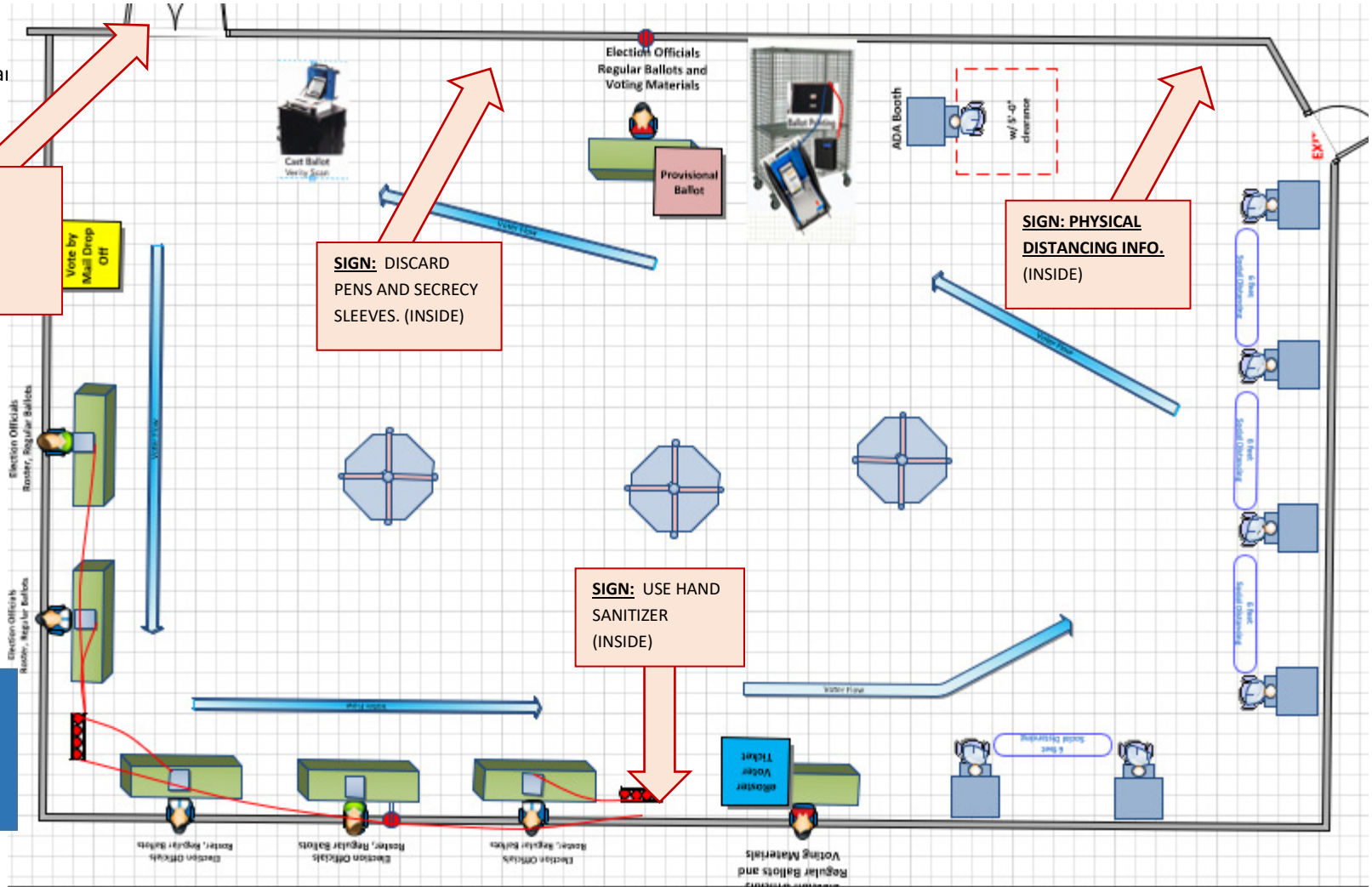

COVID-19 Prevention Action Plan – Poll Places



Fairfield – A Girls Place:



10x Social Distance Markers

MAXIMUM OCCUPANCY: 15

SIGN: USE HAND SANITIZER (INSIDE)

SIGN (outside):
 1) MAXIMUM OCCUPANCY;
 2) USE HAND SANITIZER;
 3) PHYSICAL DISTANCING INFO;

SIGN: CURBSIDE VOTING AVAILABLE (OUTSIDE)

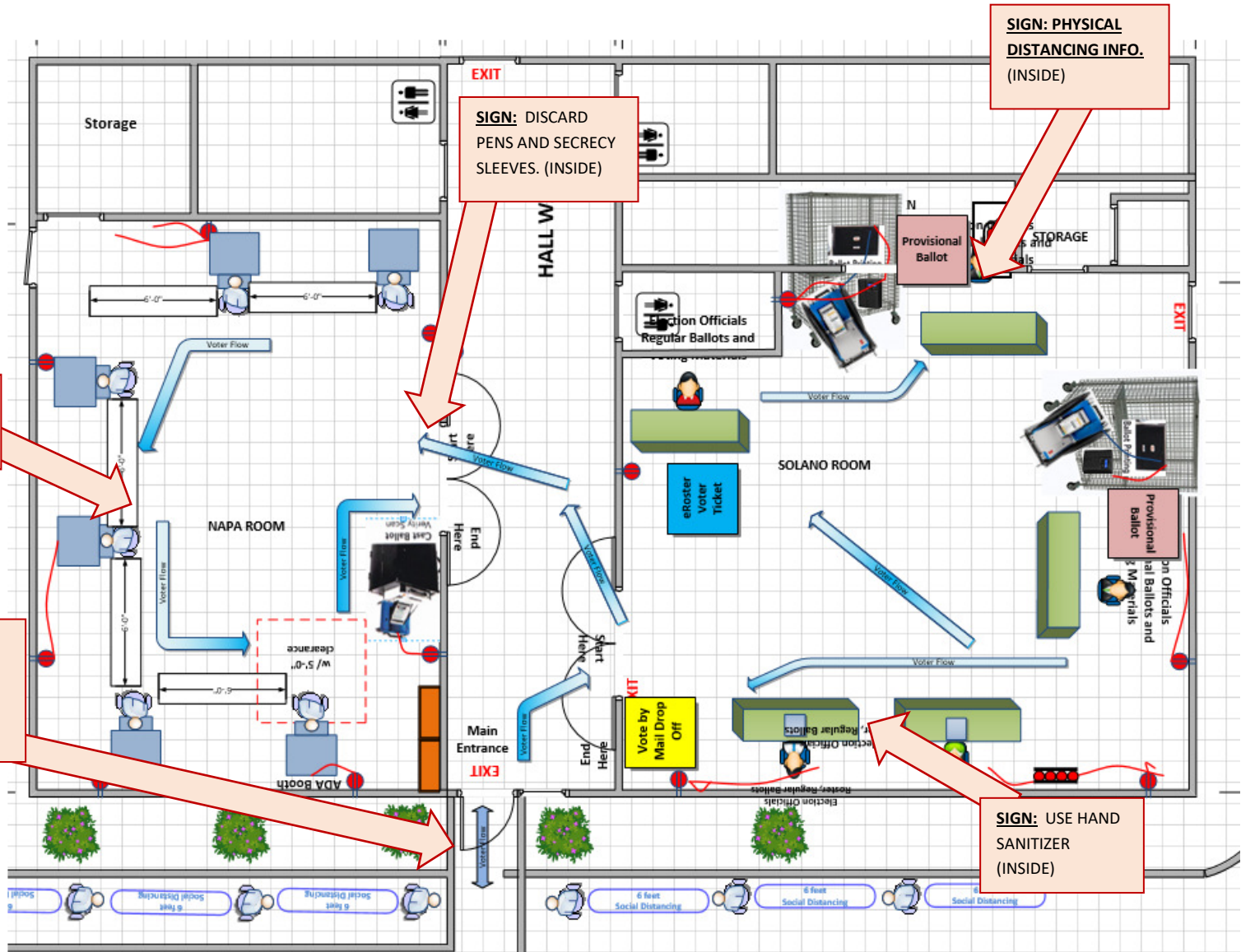

COVID-19 Prevention Action Plan – Poll Places



Fairfield – Bethel Community Church:



6x Social Distance Markers

MAXIMUM OCCUPANCY: 15

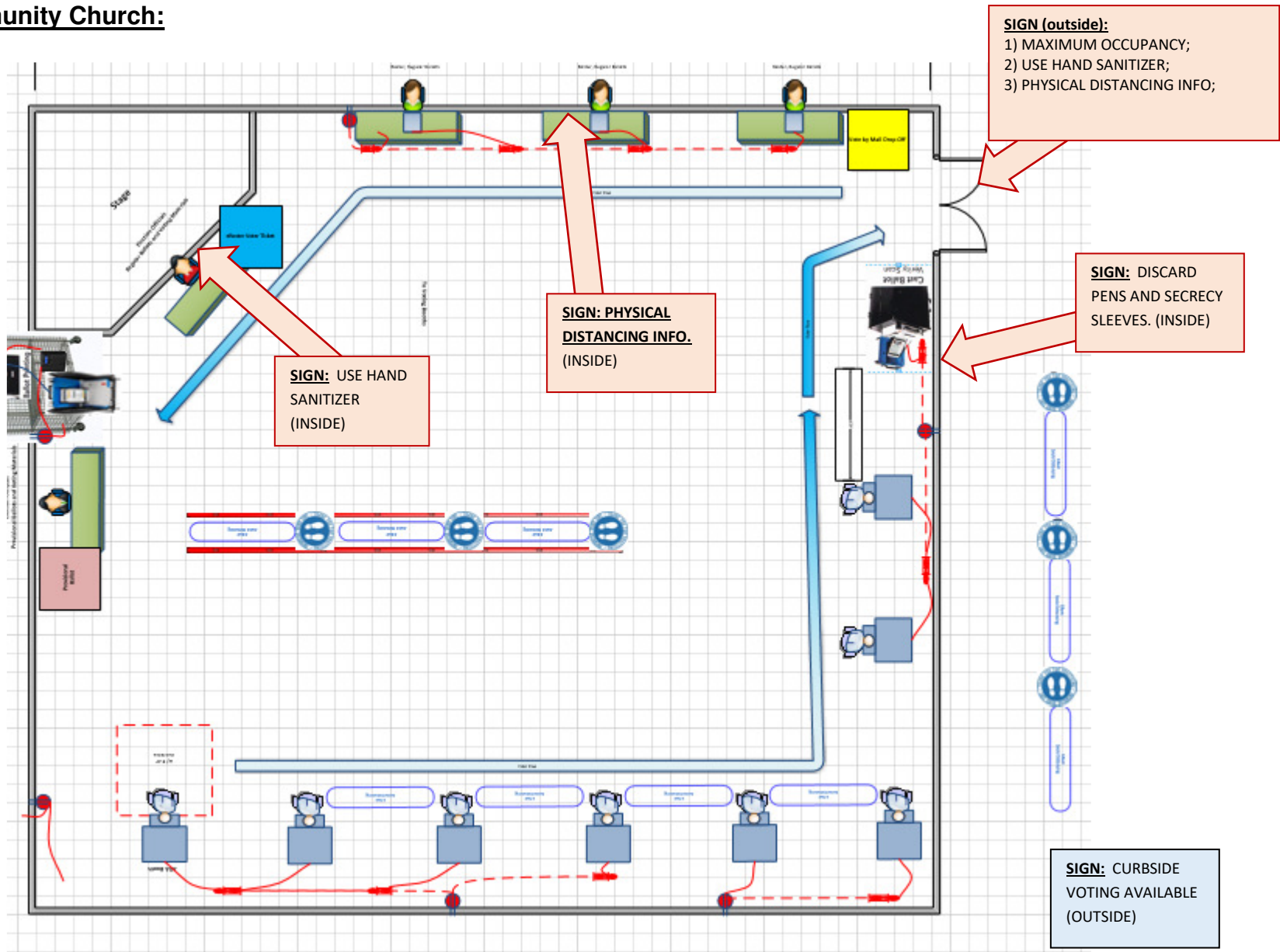

COVID-19 Prevention Action Plan – Poll Places



Fairfield – Calvary Chapel Solano



5x Social Distance Markers

**MAXIMUM OCCUPANCY:
15**

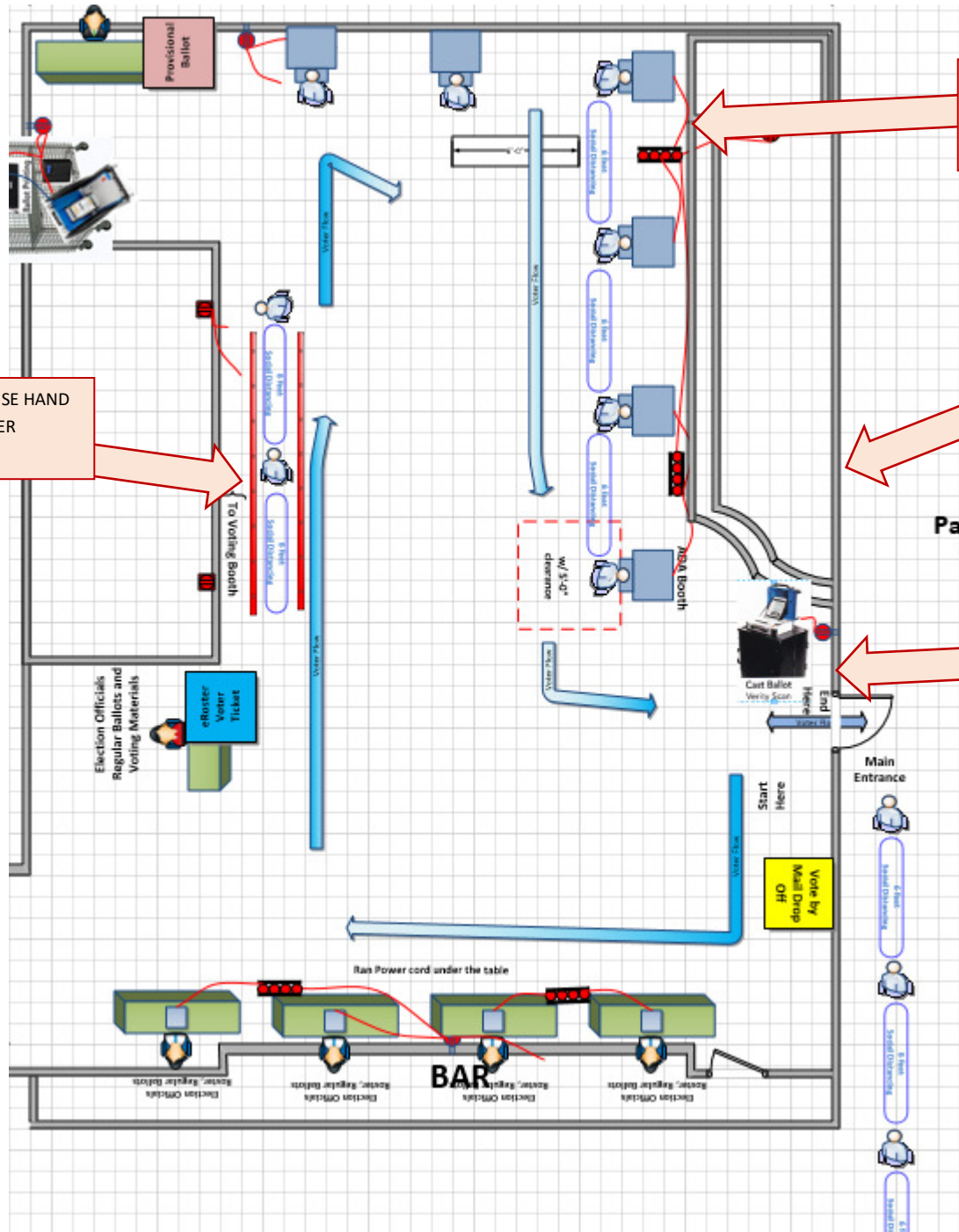

SIGN: USE HAND SANITIZER (INSIDE)

SIGN: PHYSICAL DISTANCING INFO. (INSIDE)

SIGN: DISCARD PENS AND SECRECY SLEEVES. (INSIDE)

SIGN (outside):
1) MAXIMUM OCCUPANCY;
2) USE HAND SANITIZER;
3) PHYSICAL DISTANCING INFO;

SIGN: CURBSIDE VOTING AVAILABLE (OUTSIDE)

COVID-19 Prevention Action Plan – Poll Places



Fairfield – Northern Solano Co. Assoc. of Realtors

MAXIMUM OCCUPANCY: 20

SIGN: DISCARD PENS AND SECRECY SLEEVES. (INSIDE)

SIGN: PHYSICAL DISTANCING INFO. (INSIDE)

SIGN (outside):
 1) MAXIMUM OCCUPANCY;
 2) USE HAND SANITIZER;
 3) PHYSICAL DISTANCING INFO;

SIGN: CURBSIDE VOTING AVAILABLE (OUTSIDE)

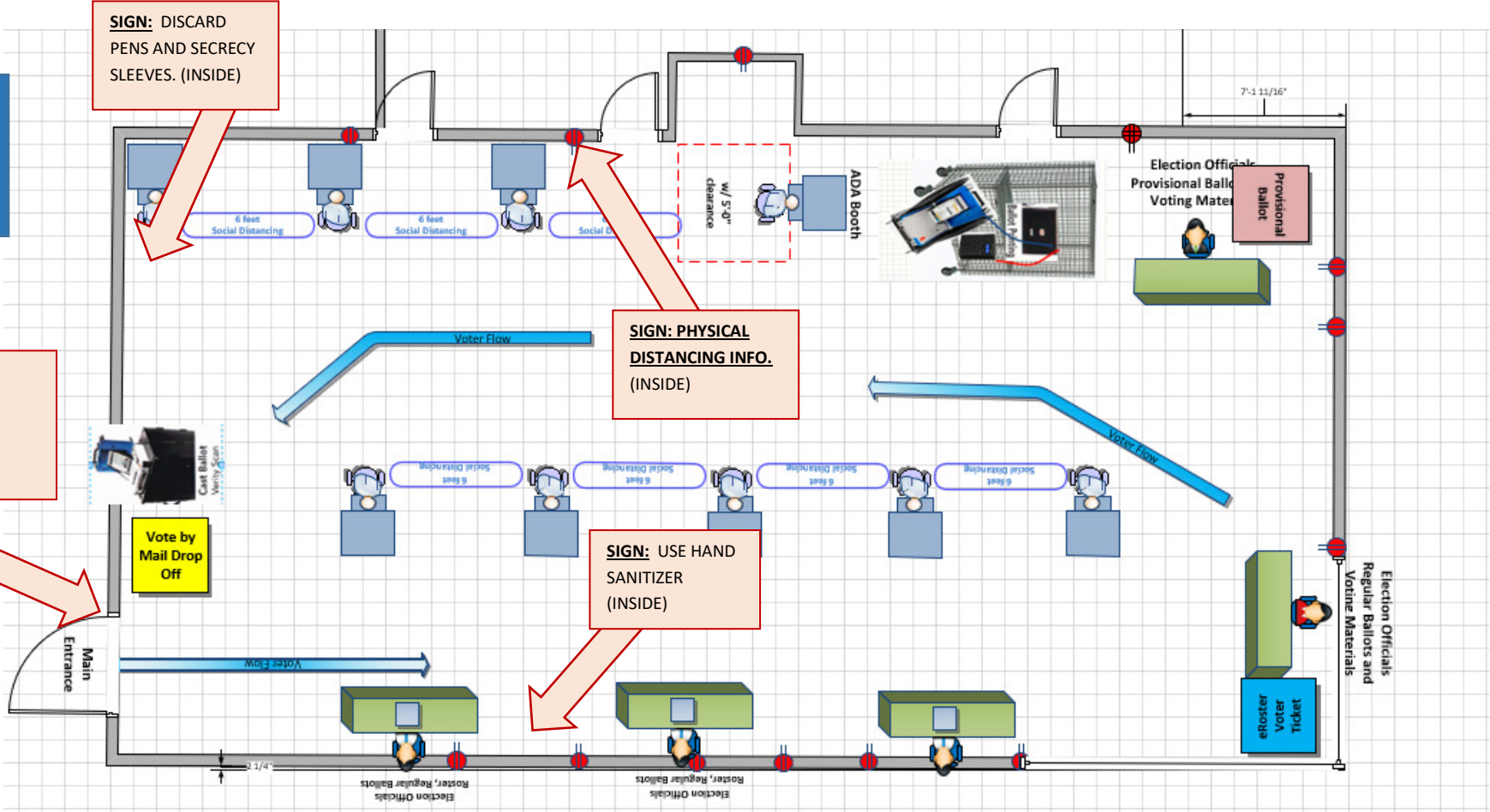

COVID-19 Prevention Action Plan – Poll Places



Fairfield – In-Shape at Rancho Solano



10x Social Distance Marker

SIGN (outside):
 1) MAXIMUM OCCUPANCY;
 2) USE HAND SANITIZER;
 3) PHYSICAL DISTANCING INFO;

MAXIMUM OCCUPANCY: 10

SIGN: CURBSIDE VOTING AVAILABLE (OUTSIDE)

SIGN: DISCARD PENS AND SECRECY SLEEVES. (INSIDE)

SIGN: USE HAND SANITIZER (INSIDE)

SIGN: PHYSICAL DISTANCING INFO. (INSIDE)

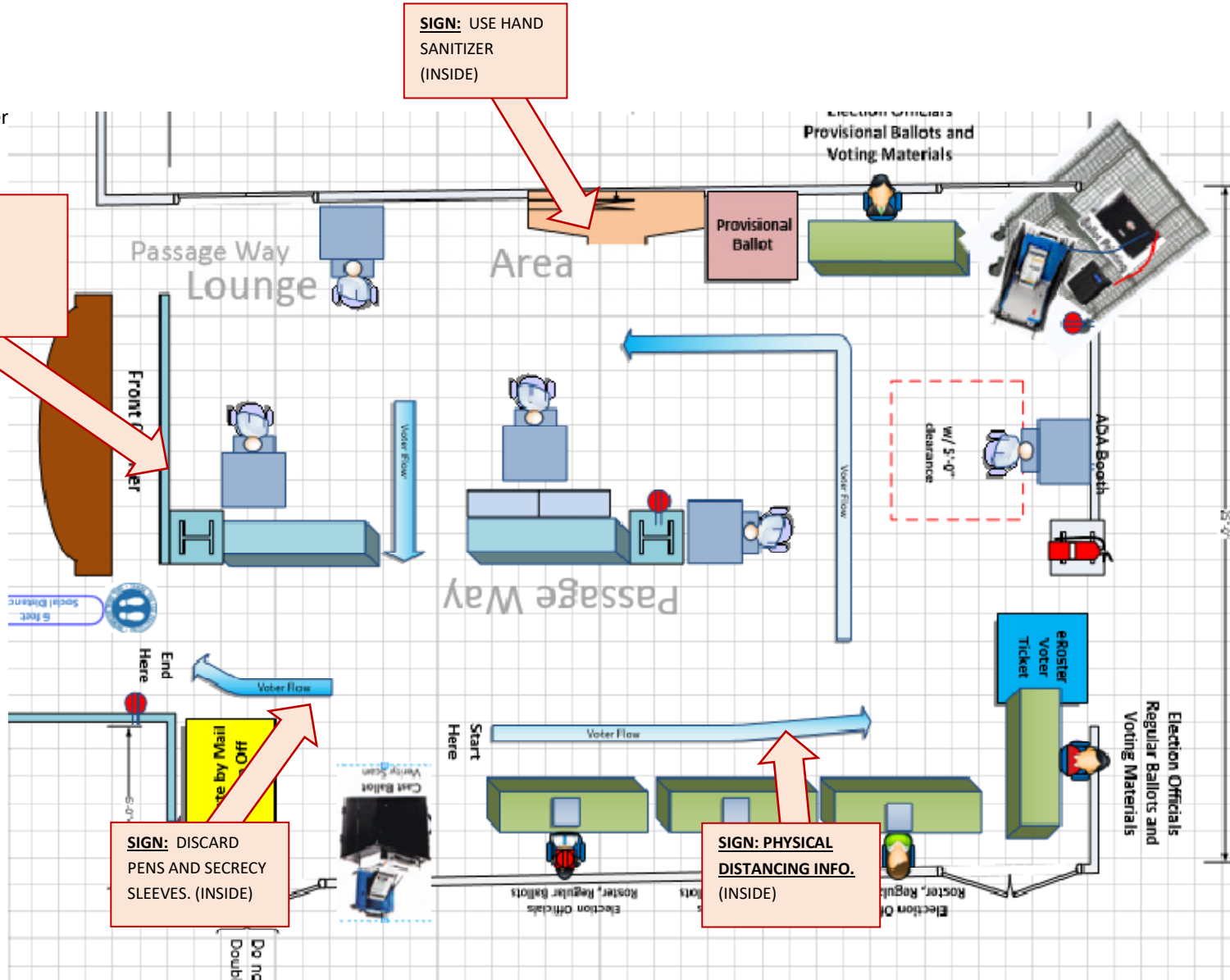

COVID-19 Prevention Action Plan – Poll Places



Fairfield – Community United Methodist Church



10x Social Distance Markers

MAXIMUM OCCUPANCY: 15

SIGN (outside):
1) MAXIMUM OCCUPANCY;
2) USE HAND SANITIZER;
3) PHYSICAL DISTANCING INFO;

SIGN: DISCARD PENS AND SECRECY SLEEVES. (INSIDE)

SIGN: PHYSICAL DISTANCING INFO. (INSIDE)

SIGN: CURBSIDE VOTING AVAILABLE (OUTSIDE)

SIGN: USE HAND SANITIZER (INSIDE)

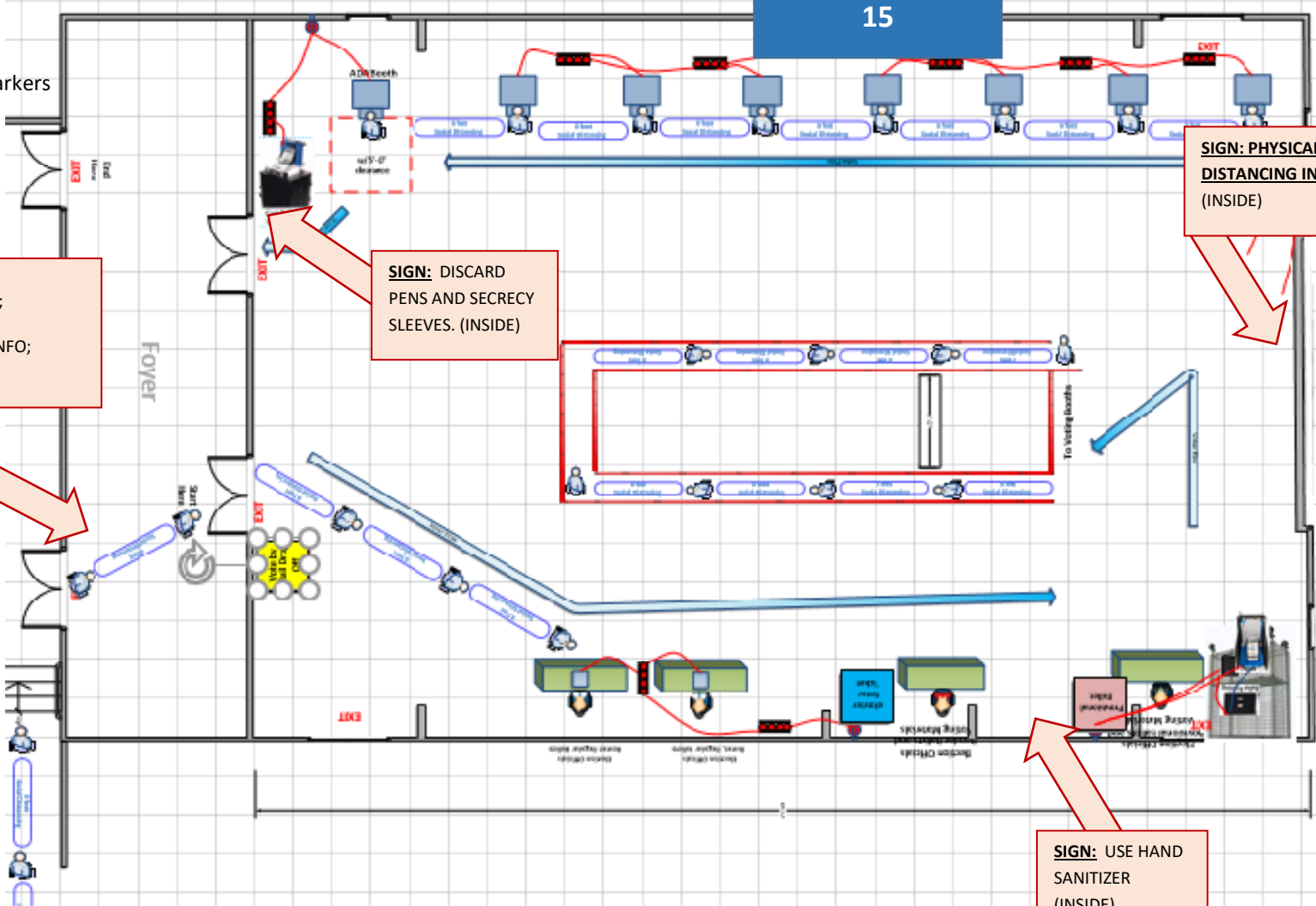

COVID-19 Prevention Action Plan – Poll Places



Fairfield – Fairfield First Baptist Church



10x Social Distance Markers

SIGN (outside):
 1) MAXIMUM OCCUPANCY;
 2) USE HAND SANITIZER;
 3) PHYSICAL DISTANCING INFO;

SIGN: CURBSIDE VOTING AVAILABLE (OUTSIDE)

MAXIMUM OCCUPANCY:
 10

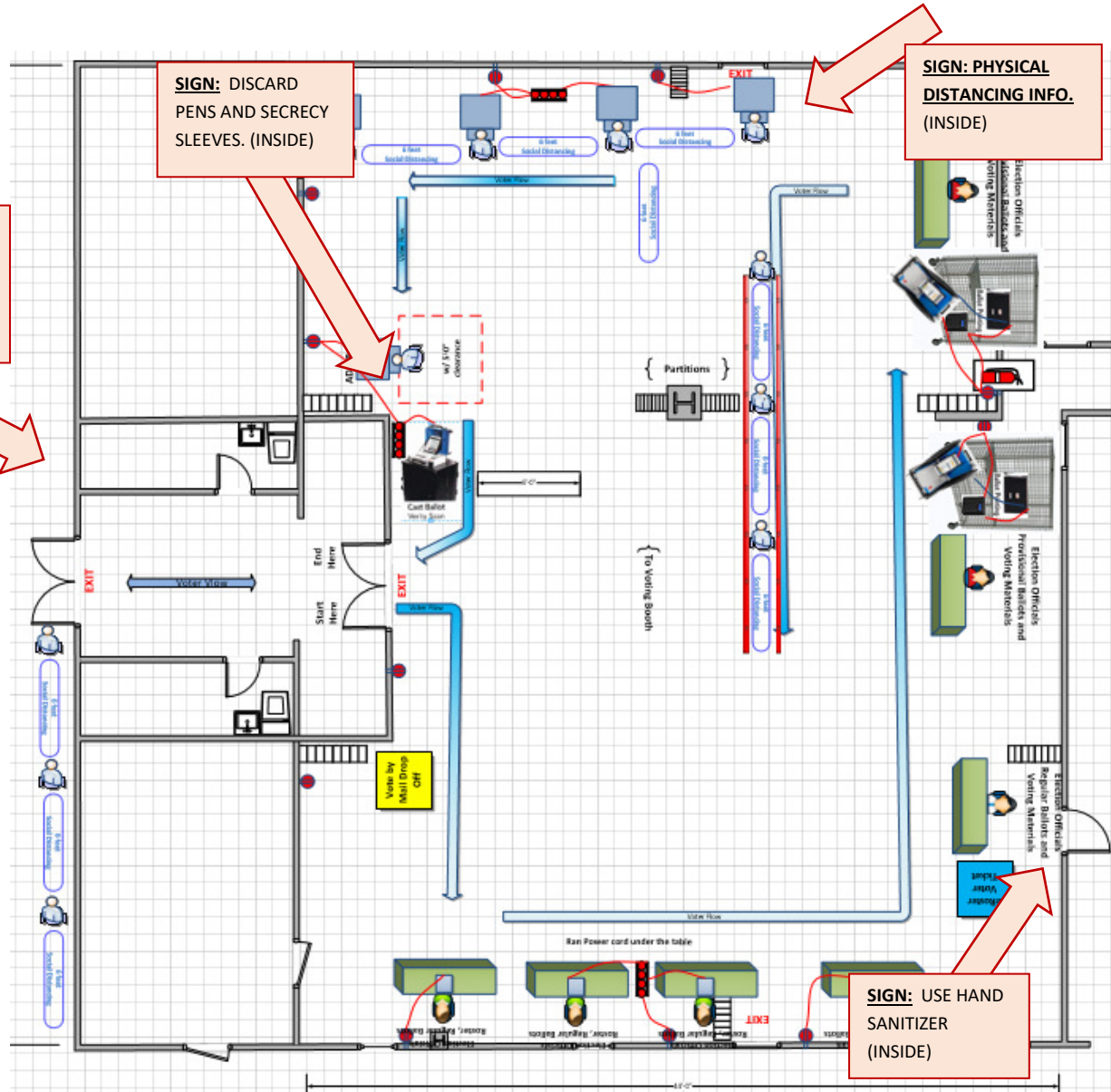

COVID-19 Prevention Action Plan – Poll Places



Fairfield – Fairfield-Suisun Unified School District Office



10x Social Distance Markers

MAXIMUM OCCUPANCY: 15

SIGN: DISCARD PENS AND SECRECY SLEEVES. (INSIDE)

SIGN: CURBSIDE VOTING AVAILABLE (OUTSIDE)

SIGN (outside):
 1) MAXIMUM OCCUPANCY;
 2) USE HAND SANITIZER;
 3) PHYSICAL DISTANCING INFO;

SIGN: PHYSICAL DISTANCING INFO. (INSIDE)

SIGN: USE HAND SANITIZER (INSIDE)

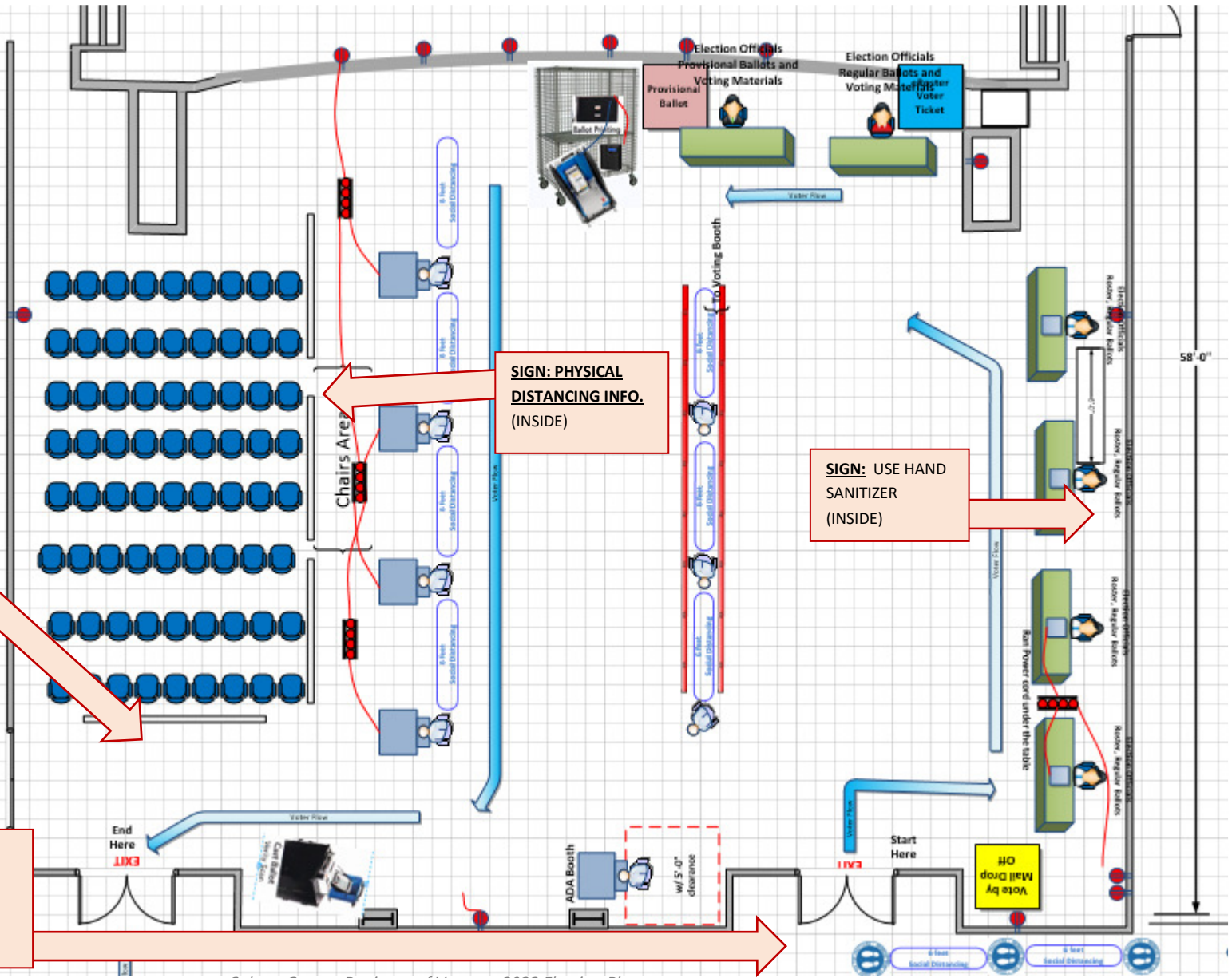

COVID-19 Prevention Action Plan – Poll Places



Fairfield – Grace Episcopal Church



6x Social Distance Markers

MAXIMUM OCCUPANCY:
10

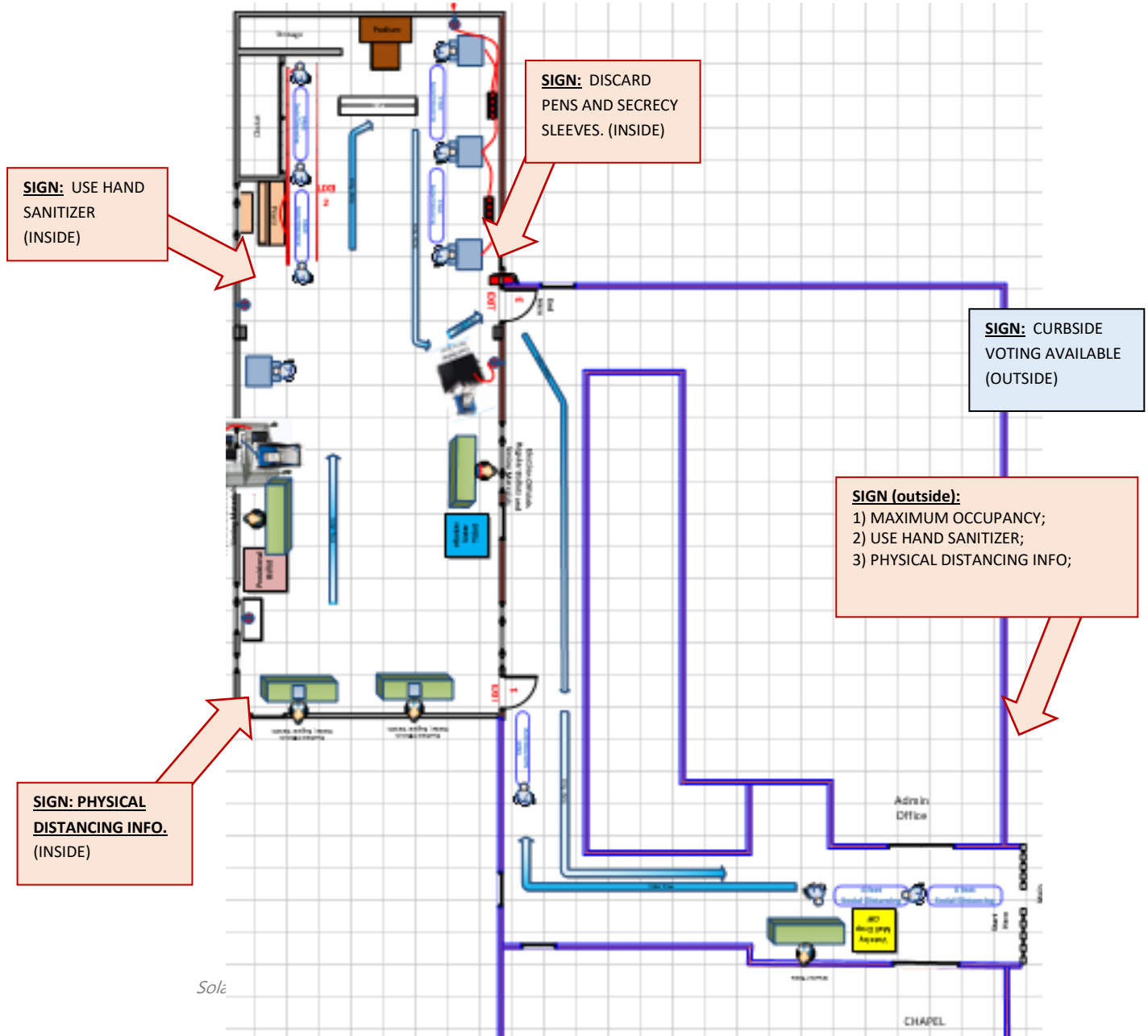

COVID-19 Prevention Action Plan – Poll Places



Fairfield – Cordelia Hills Elem. School:



20x Social Distance Markers

MAXIMUM OCCUPANCY:
10

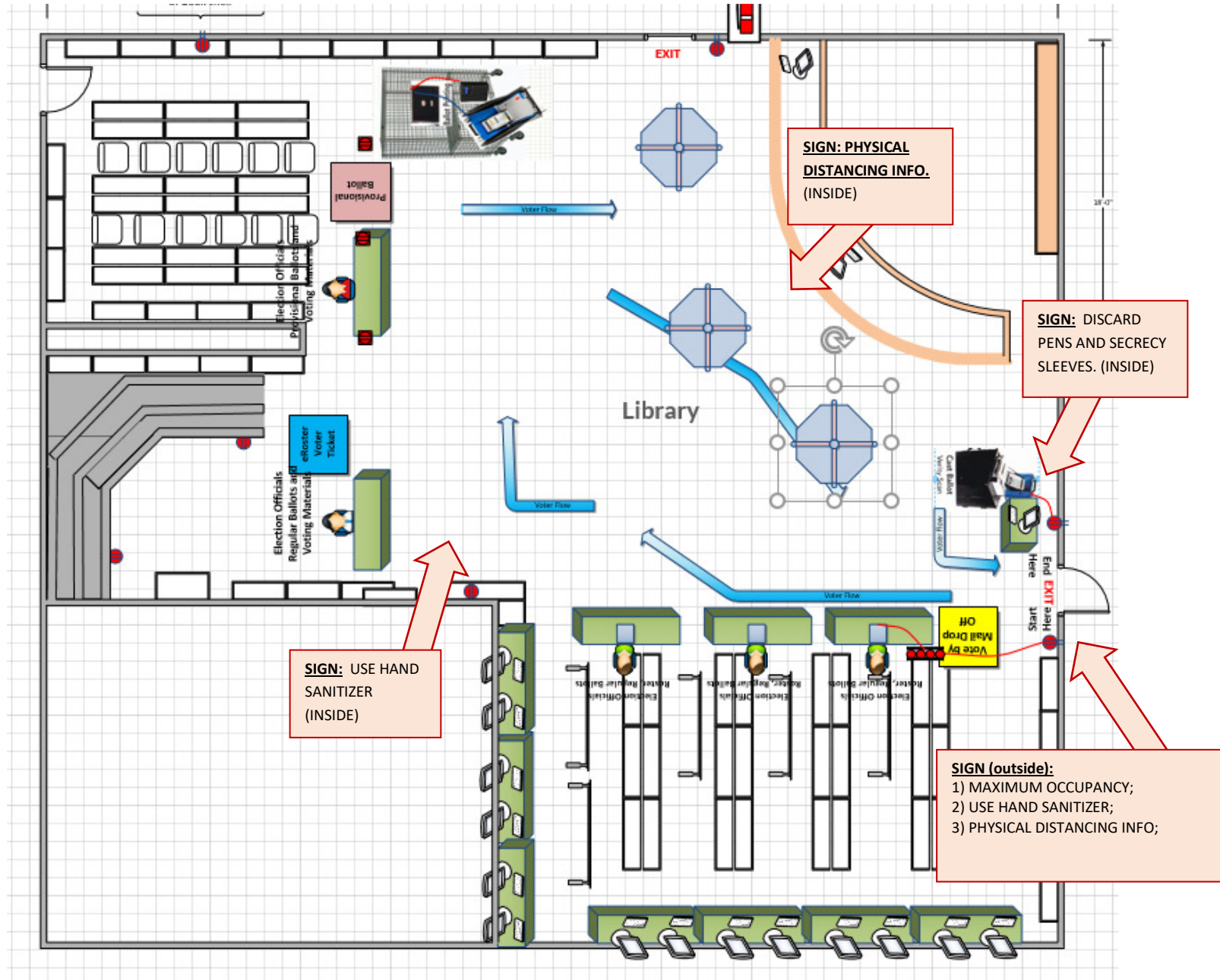

SIGN: CURBSIDE VOTING AVAILABLE (OUTSIDE)

COVID-19 Prevention Action Plan – Poll Places



Fairfield – Liberty Church:



4x Social Distance Markers

MAXIMUM OCCUPANCY:
15

SIGN: PHYSICAL DISTANCING INFO.
(INSIDE)

SIGN: USE HAND SANITIZER
(INSIDE)

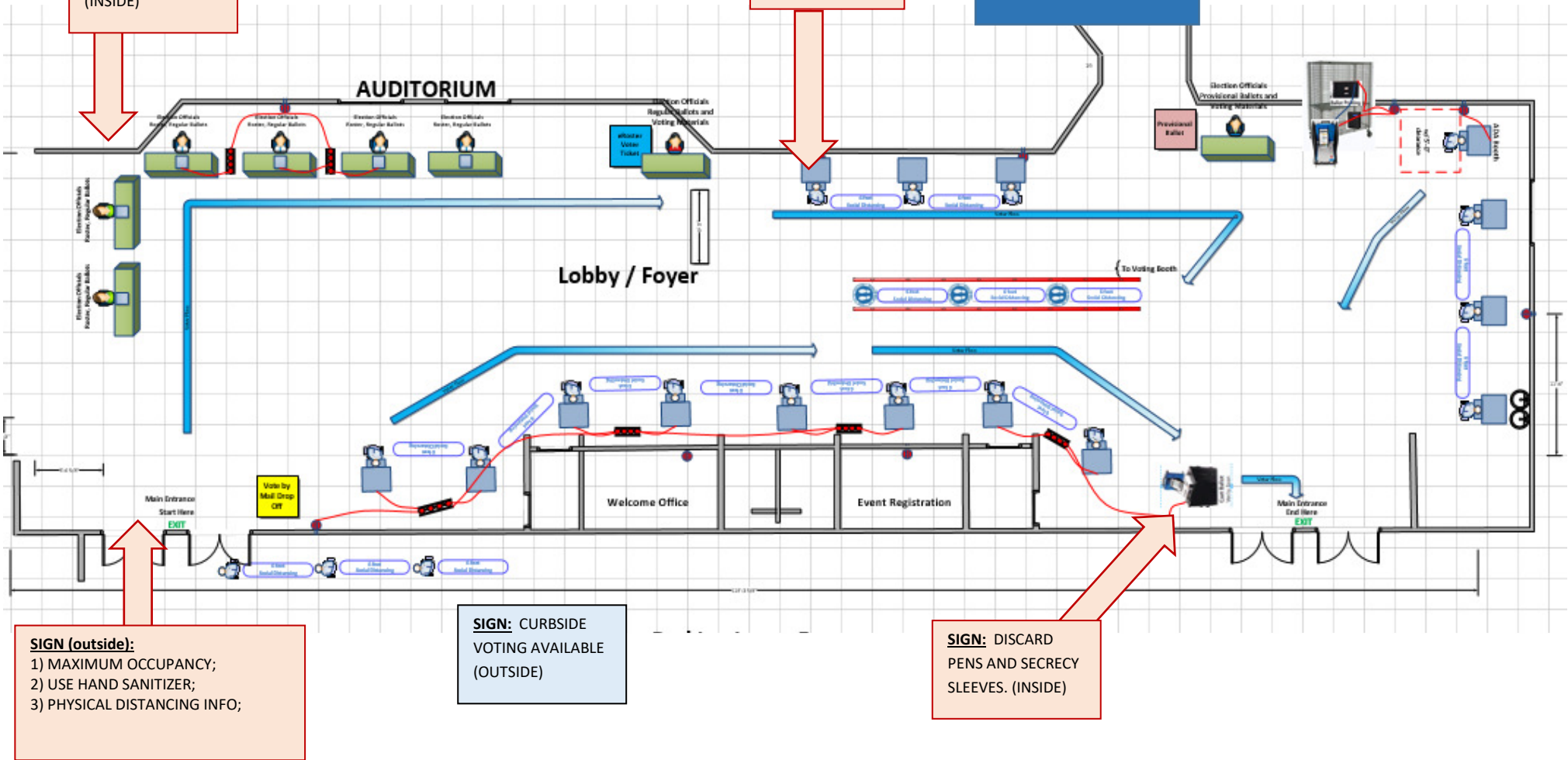

SIGN (outside):
1) MAXIMUM OCCUPANCY;
2) USE HAND SANITIZER;
3) PHYSICAL DISTANCING INFO;

SIGN: CURBSIDE VOTING AVAILABLE
(OUTSIDE)

SIGN: DISCARD PENS AND SECRECY SLEEVES.
(INSIDE)

COVID-19 Prevention Action Plan – Poll Places



Fairfield – Solano County Office of Education



10x Social Distance Markers

SIGN (outside):
1) MAXIMUM OCCUPANCY;
2) USE HAND SANITIZER;
3) PHYSICAL DISTANCING INFO;

SIGN: CURBSIDE VOTING AVAILABLE (OUTSIDE)

MAXIMUM OCCUPANCY:
25

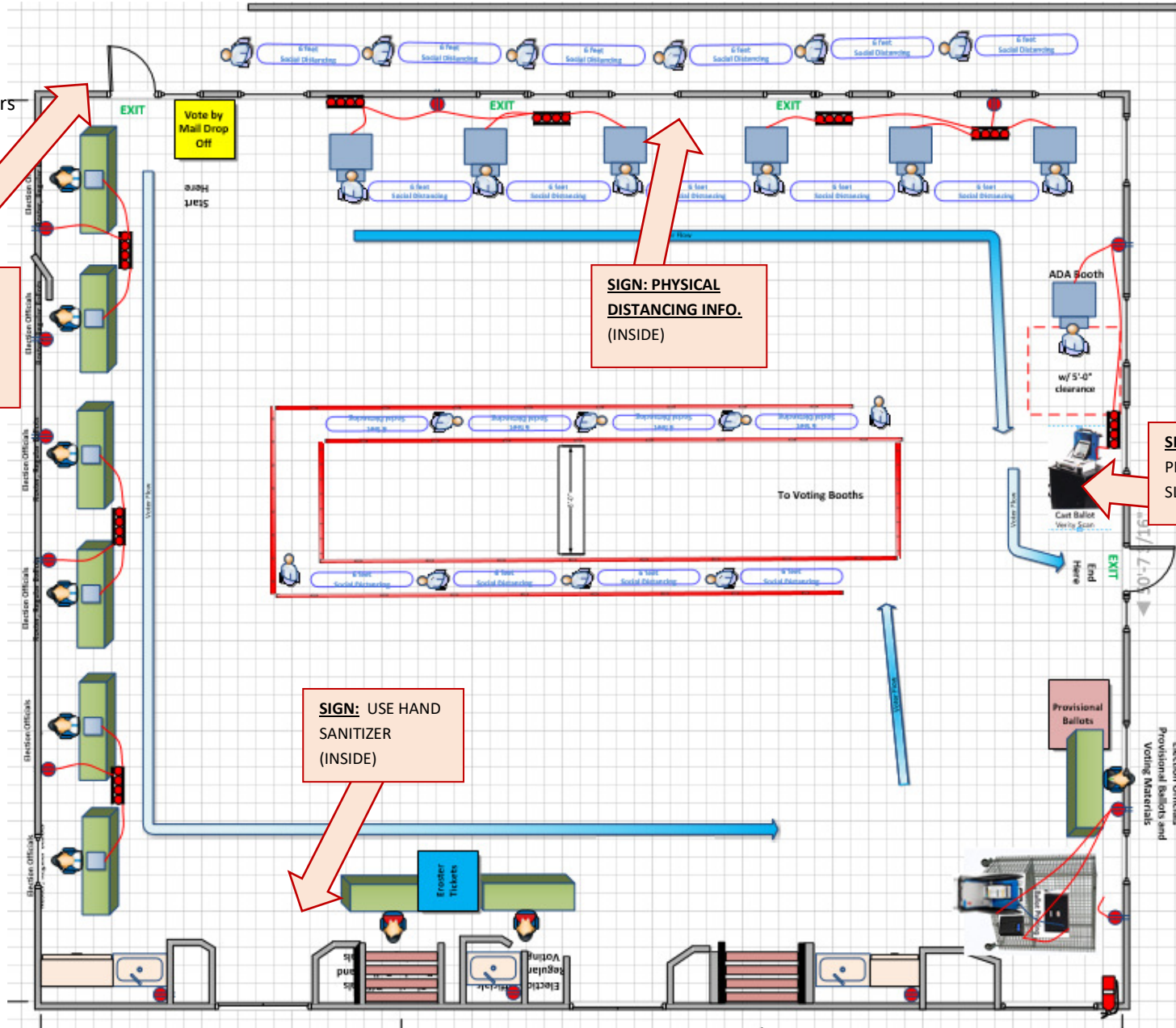

SIGN: PHYSICAL DISTANCING INFO. (INSIDE)

SIGN: DISCARD PENS AND SECRECY SLEEVES. (INSIDE)

SIGN: USE HAND SANITIZER (INSIDE)

COVID-19 Prevention Action Plan – Poll Places



Fairfield – Rodriguez High School:

MAXIMUM OCCUPANCY:
10

SIGN: CURBSIDE VOTING AVAILABLE (OUTSIDE)

SIGN (outside):
1) MAXIMUM OCCUPANCY;
2) USE HAND SANITIZER;
3) PHYSICAL DISTANCING INFO;

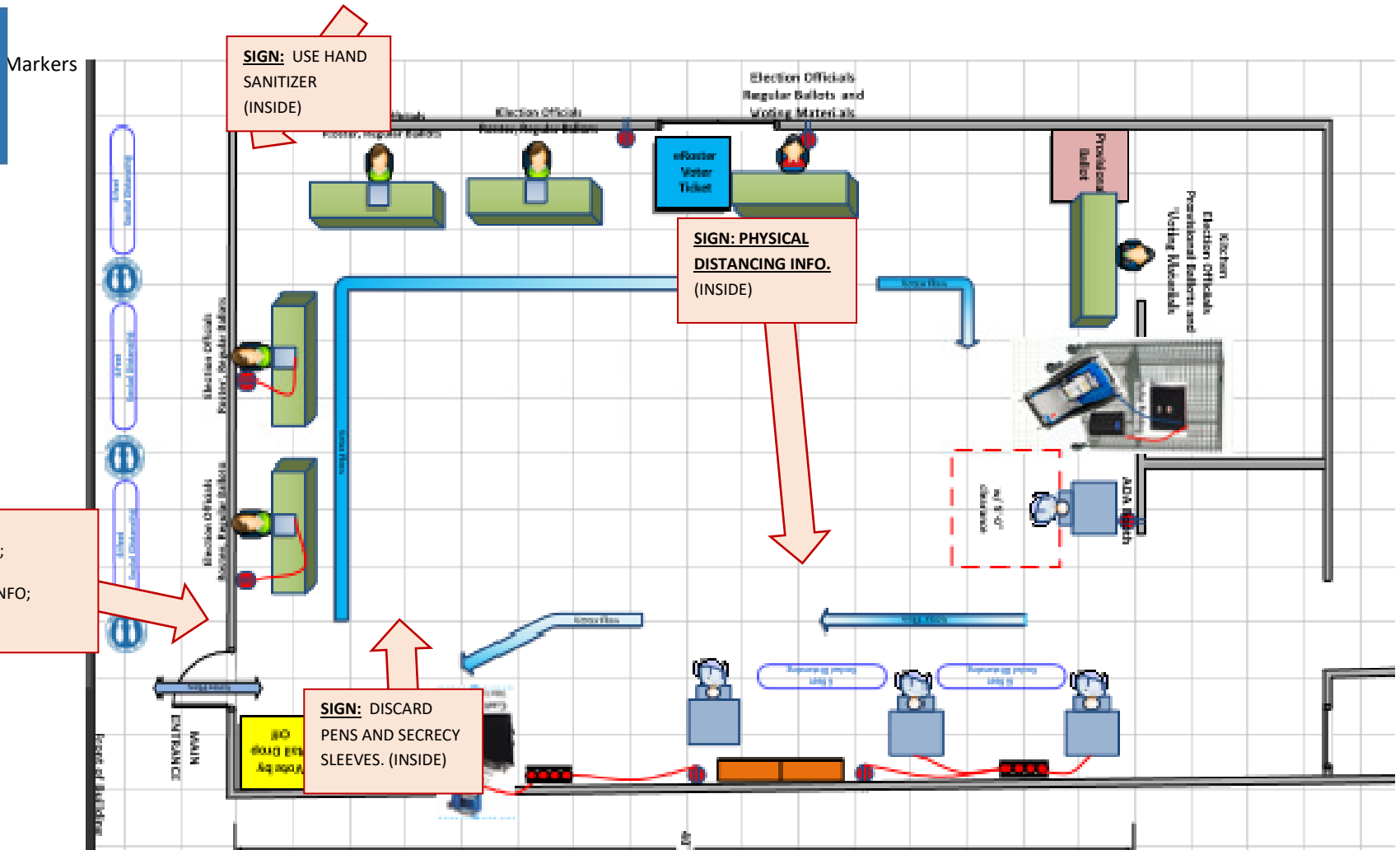

COVID-19 Prevention Action Plan – Poll Places



Fairfield – Solano Valley Church



10x Social Distance Markers

MAXIMUM OCCUPANCY:
20

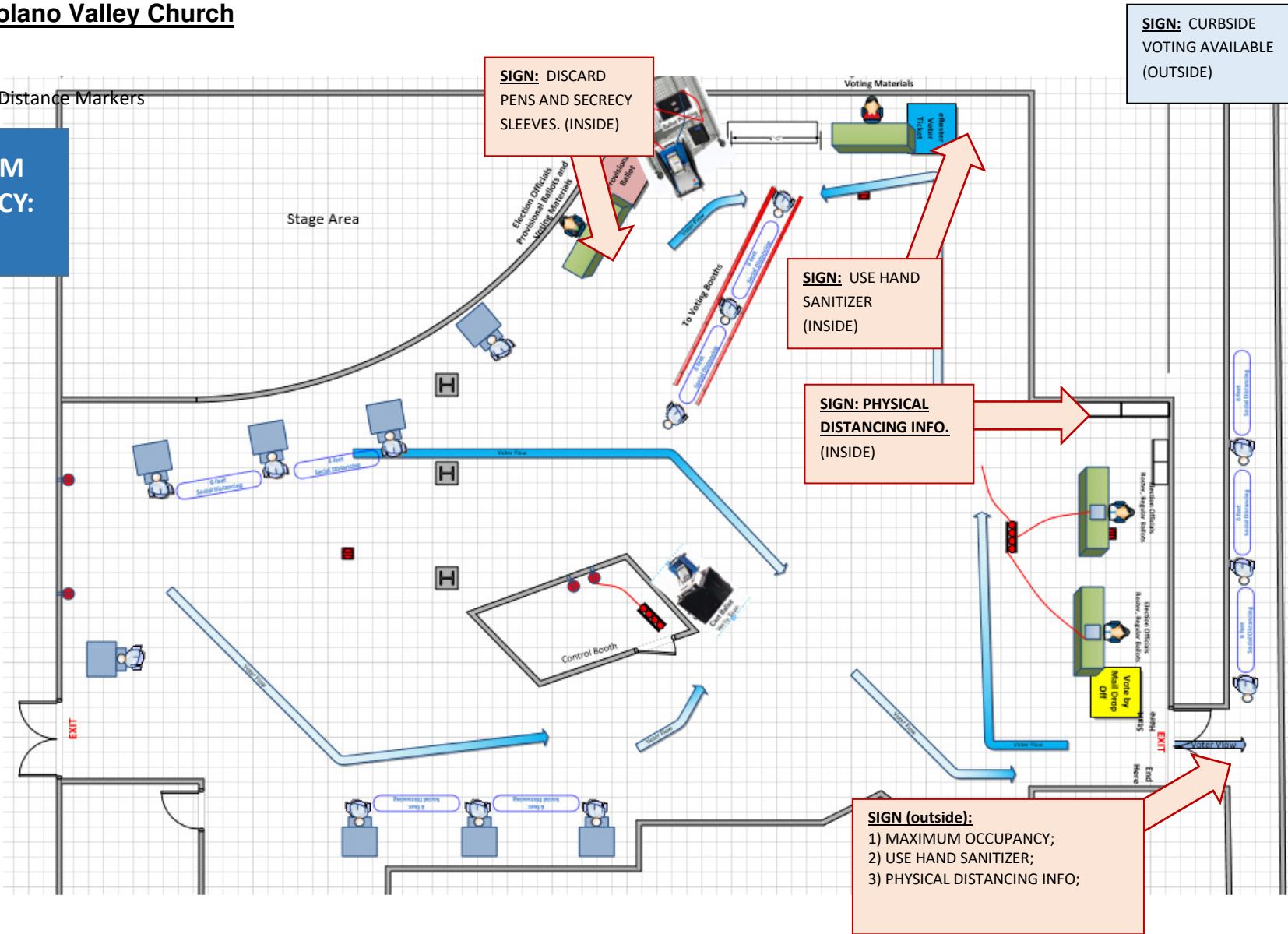

COVID-19 Prevention Action Plan – Poll Places



Fairfield – Word of Faith Church

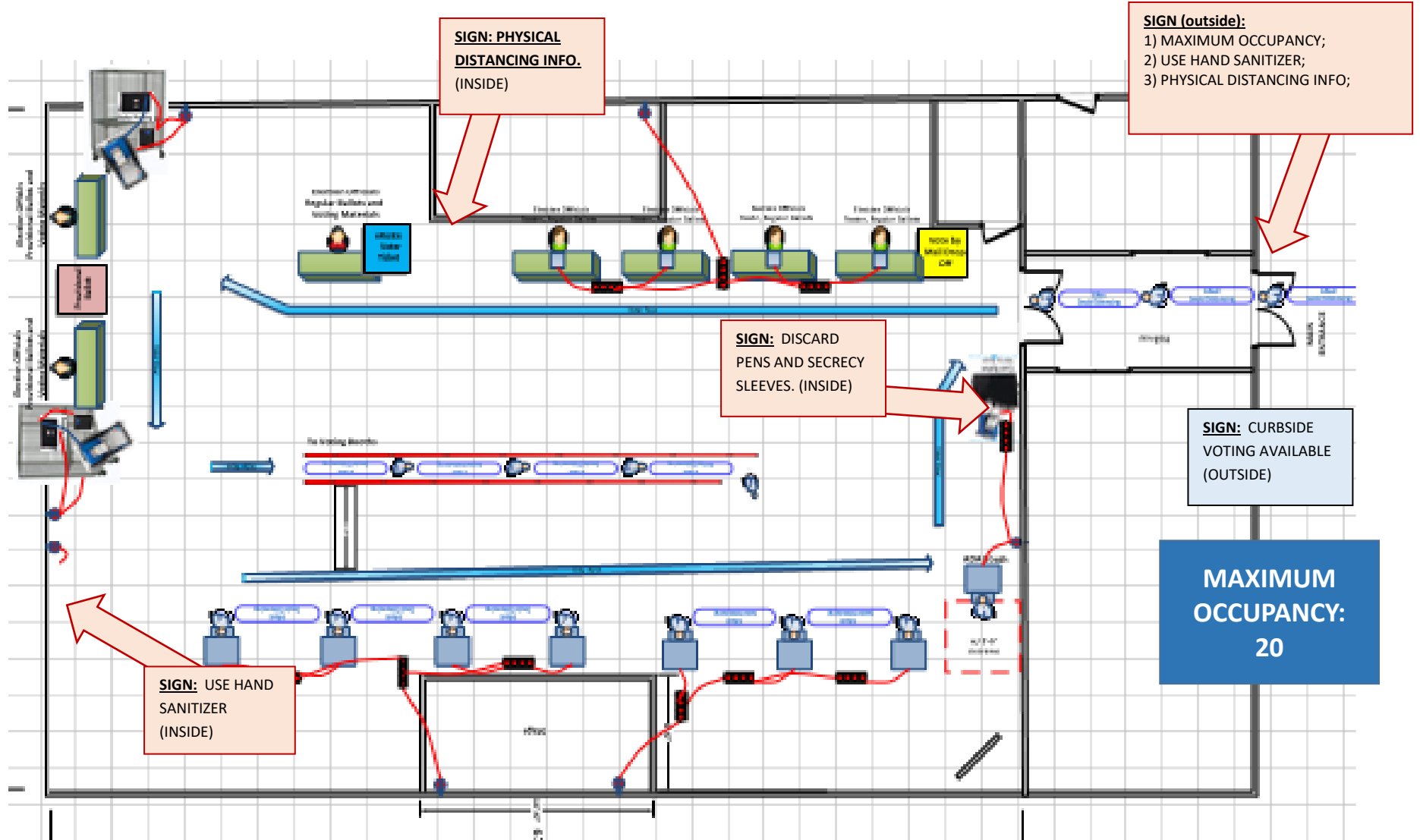

COVID-19 Prevention Action Plan – Poll Places



Fairfield – Tolenas Academy

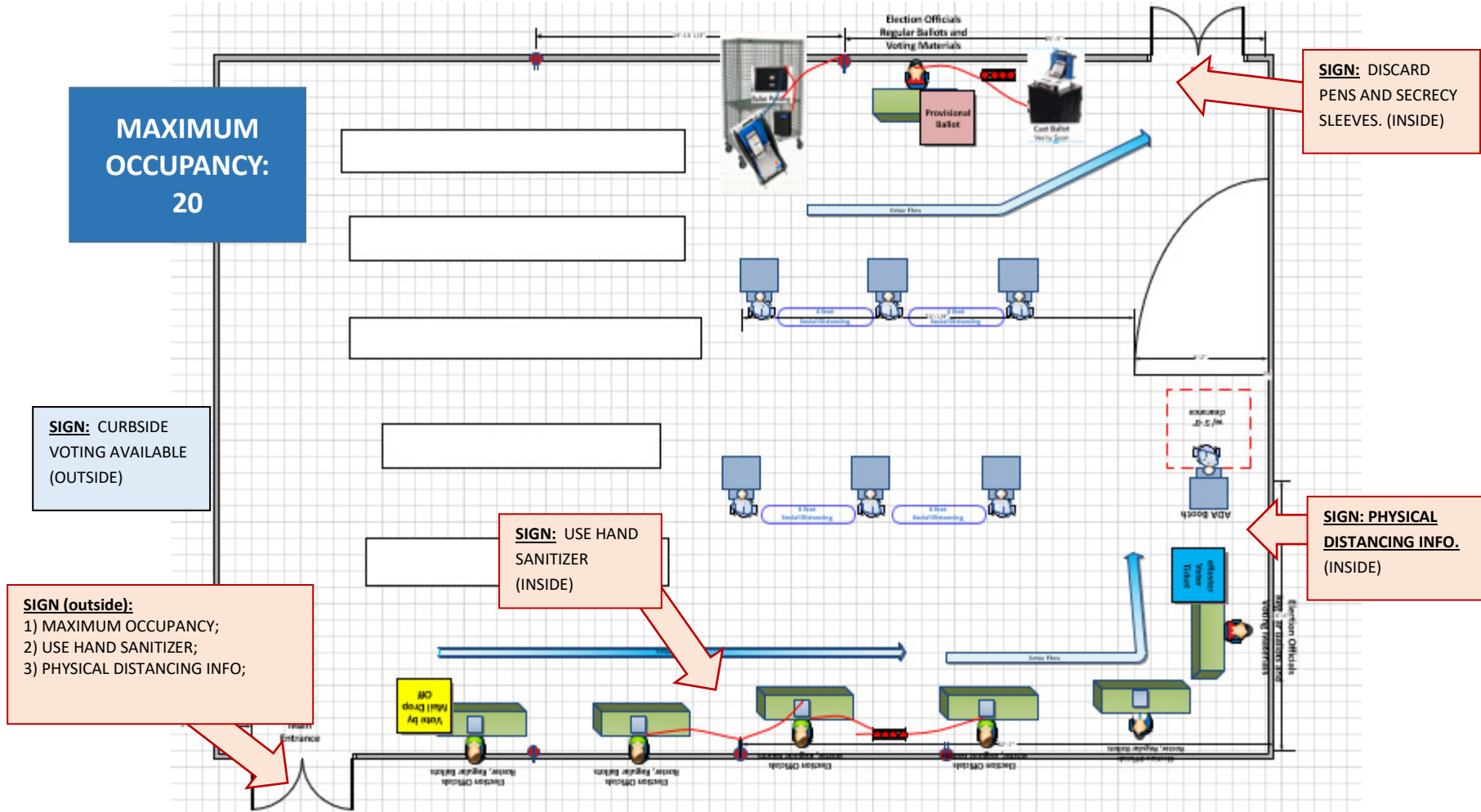

COVID-19 Prevention Action Plan – Poll Places



Vacaville – Bible Church

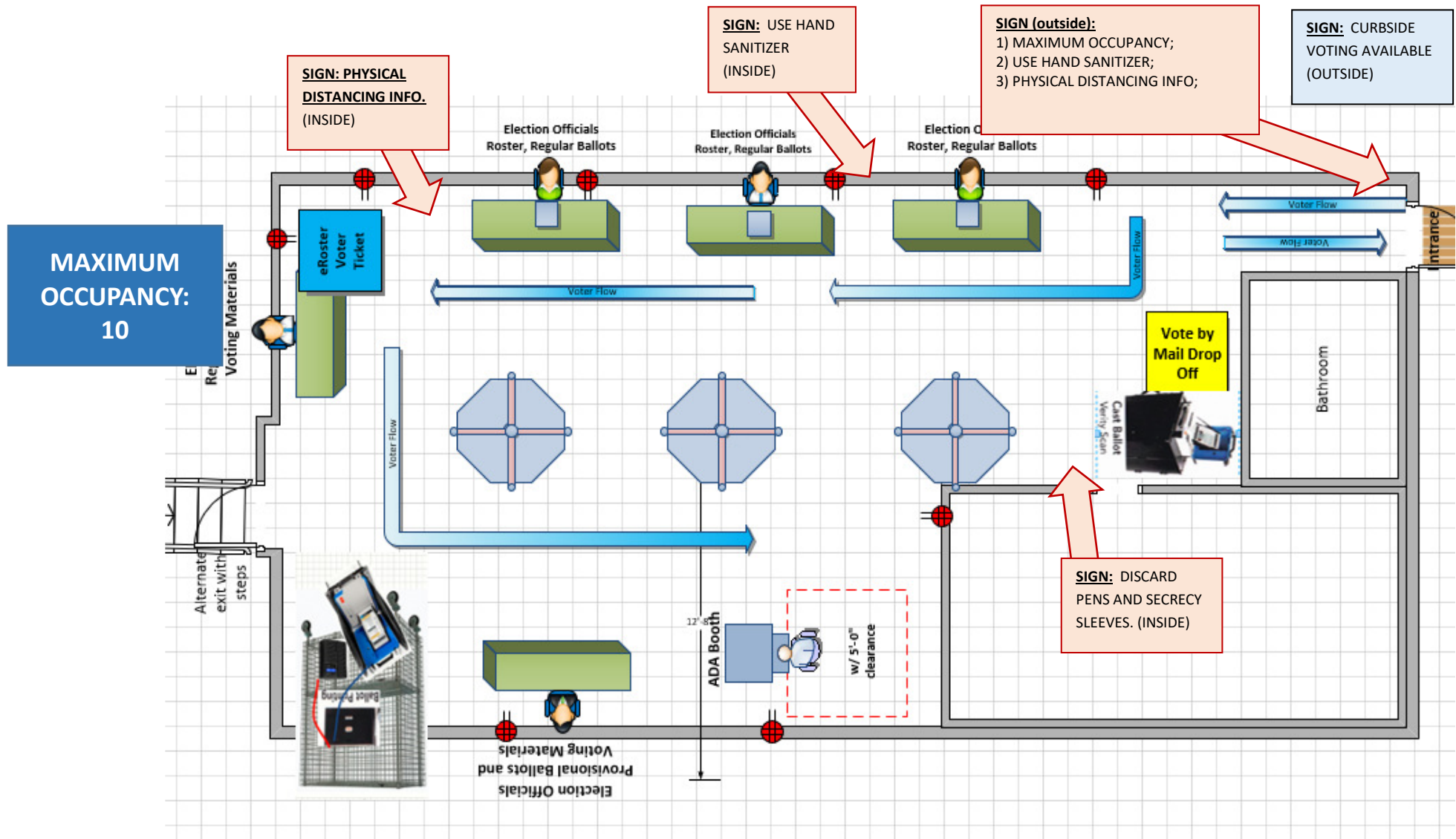

COVID-19 Prevention Action Plan – Poll Places



Vacaville – Covenant Community Church



10x Social Distance Markers

**MAXIMUM
OCCUPANCY:
25**

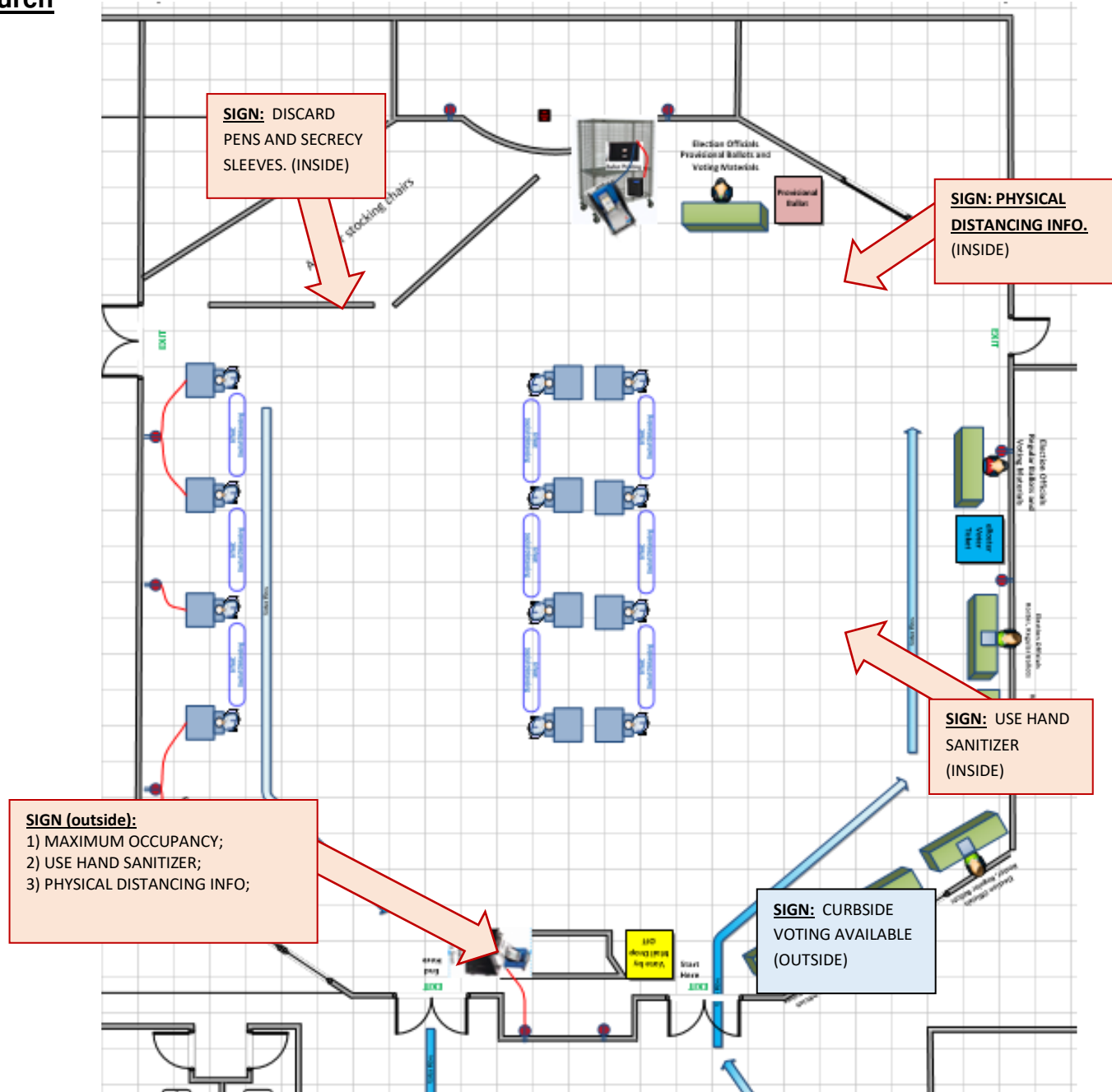

COVID-19 Prevention Action Plan – Poll Places



Vacaville – First Baptist Church



8x Social Distance Markers

MAXIMUM OCCUPANCY: 15

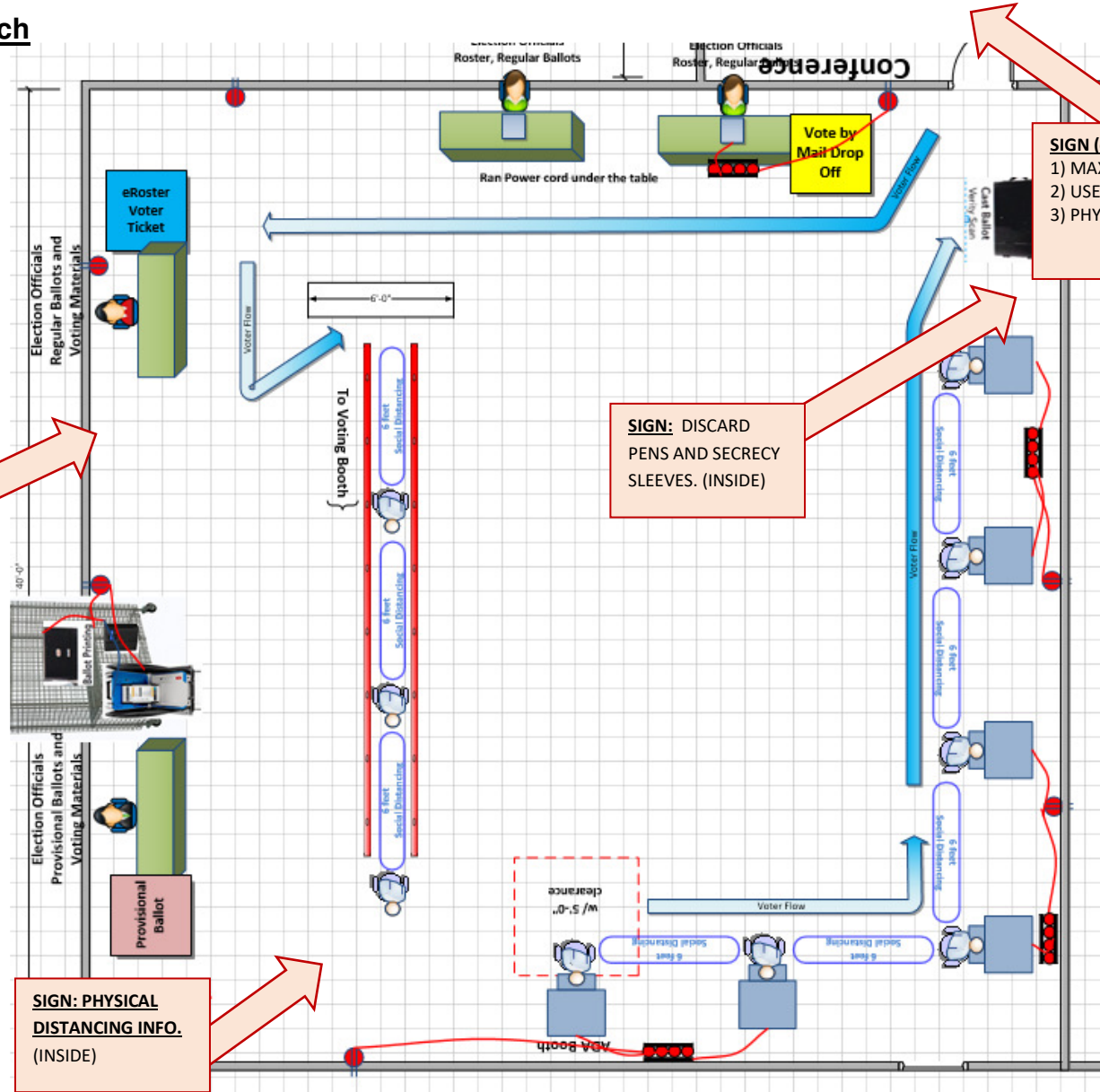

SIGN: USE HAND SANITIZER (INSIDE)

SIGN: DISCARD PENS AND SECRECY SLEEVES. (INSIDE)

SIGN (outside):
 1) MAXIMUM OCCUPANCY;
 2) USE HAND SANITIZER;
 3) PHYSICAL DISTANCING INFO;

SIGN: CURBSIDE VOTING AVAILABLE (OUTSIDE)

SIGN: PHYSICAL DISTANCING INFO. (INSIDE)

COVID-19 Prevention Action Plan – Poll Places



Vacaville – Harvest Church:



30x Social Distance Markers

MAXIMUM OCCUPANCY: 35

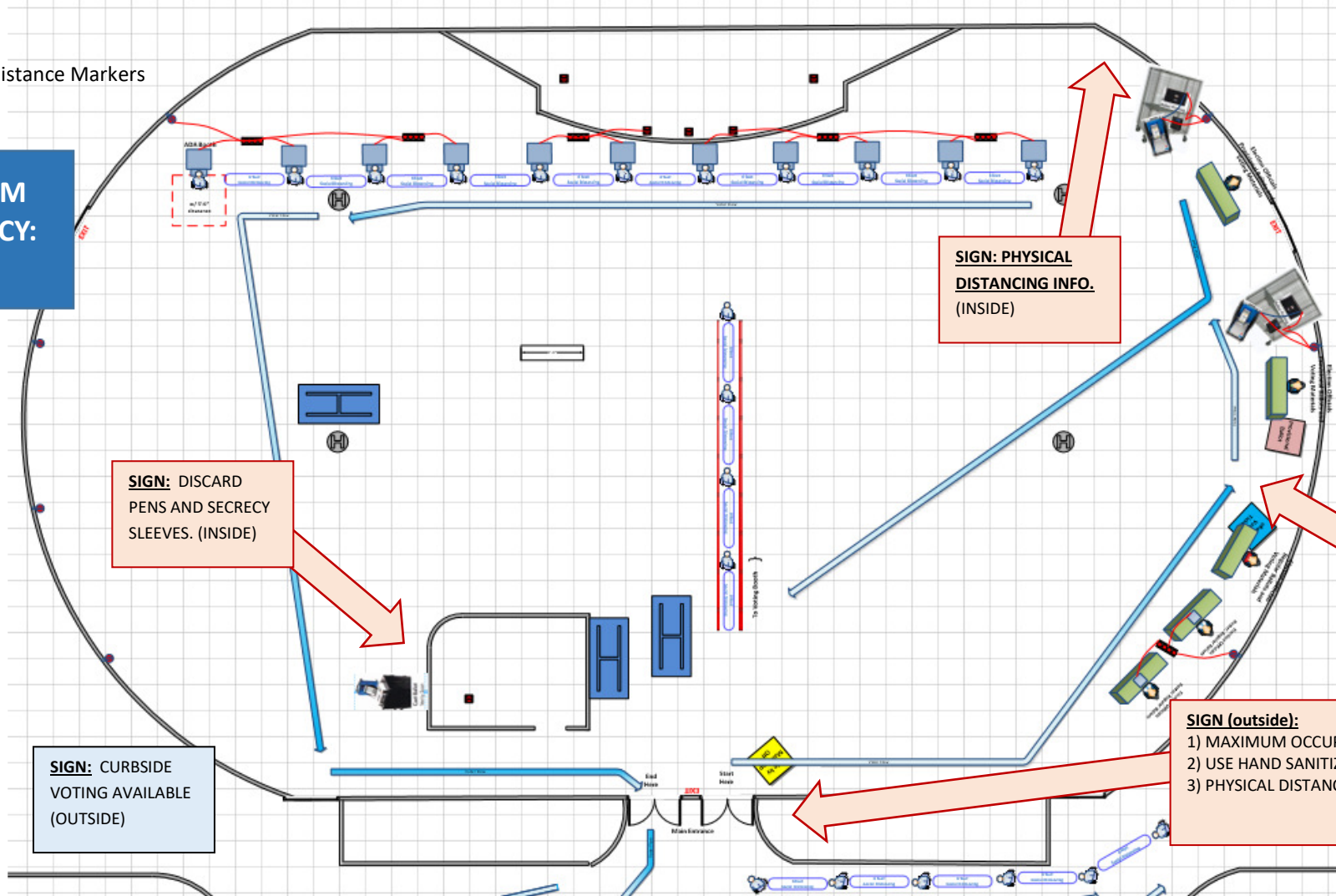

SIGN: DISCARD PENS AND SECRECY SLEEVES. (INSIDE)

SIGN: PHYSICAL DISTANCING INFO. (INSIDE)

SIGN: USE HAND SANITIZER (INSIDE)

SIGN: CURBSIDE VOTING AVAILABLE (OUTSIDE)

SIGN (outside):
1) MAXIMUM OCCUPANCY;
2) USE HAND SANITIZER;
3) PHYSICAL DISTANCING INFO;

COVID-19 Prevention Action Plan – Poll Places



Vacaville – Mission Church:



30x Social Distance Markers

MAXIMUM OCCUPANCY: 45

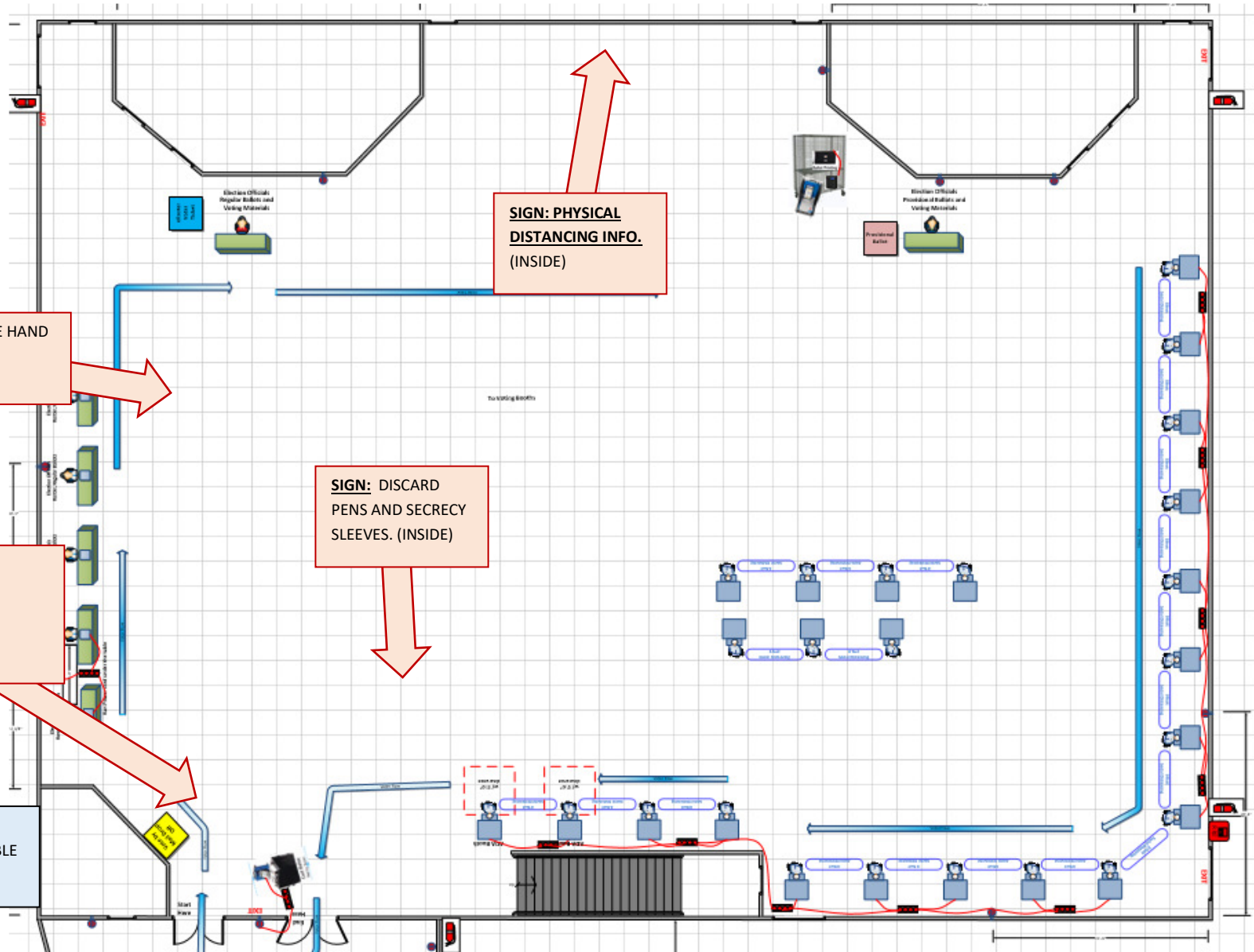

COVID-19 Prevention Action Plan – Poll Places



Vacaville – Moose Lodge



10x Social Distance Markers

MAXIMUM OCCUPANCY: 15

SIGN: DISCARD PENS AND SECRECY SLEEVES. (INSIDE)

SIGN (outside):
1) MAXIMUM OCCUPANCY;
2) USE HAND SANITIZER;
3) PHYSICAL DISTANCING INFO;

SIGN: CURBSIDE VOTING AVAILABLE (OUTSIDE)

SIGN: PHYSICAL DISTANCING INFO. (INSIDE)

SIGN: USE HAND SANITIZER (INSIDE)

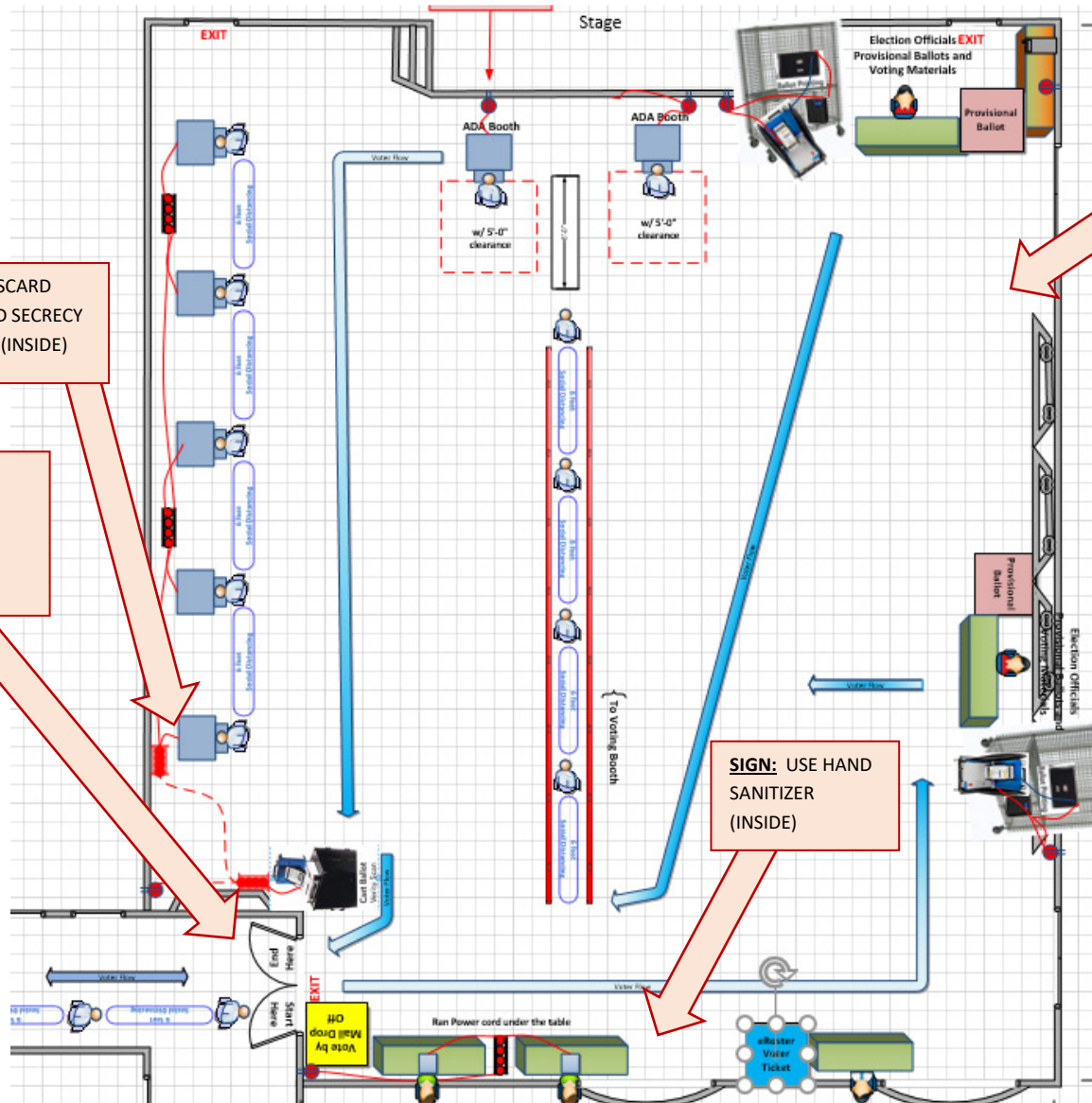

COVID-19 Prevention Action Plan – Poll Places



Vacaville – New Hope Christian Fellowship



5x Social Distance Markers

SIGN (outside):
 1) MAXIMUM OCCUPANCY;
 2) USE HAND SANITIZER;
 3) PHYSICAL DISTANCING INFO;

MAXIMUM OCCUPANCY: 25

SIGN: CURBSIDE VOTING AVAILABLE (OUTSIDE)

SIGN: DISCARD PENS AND SECRECY SLEEVES. (INSIDE)

SIGN: USE HAND SANITIZER (INSIDE)

SIGN: PHYSICAL DISTANCING INFO. (INSIDE)

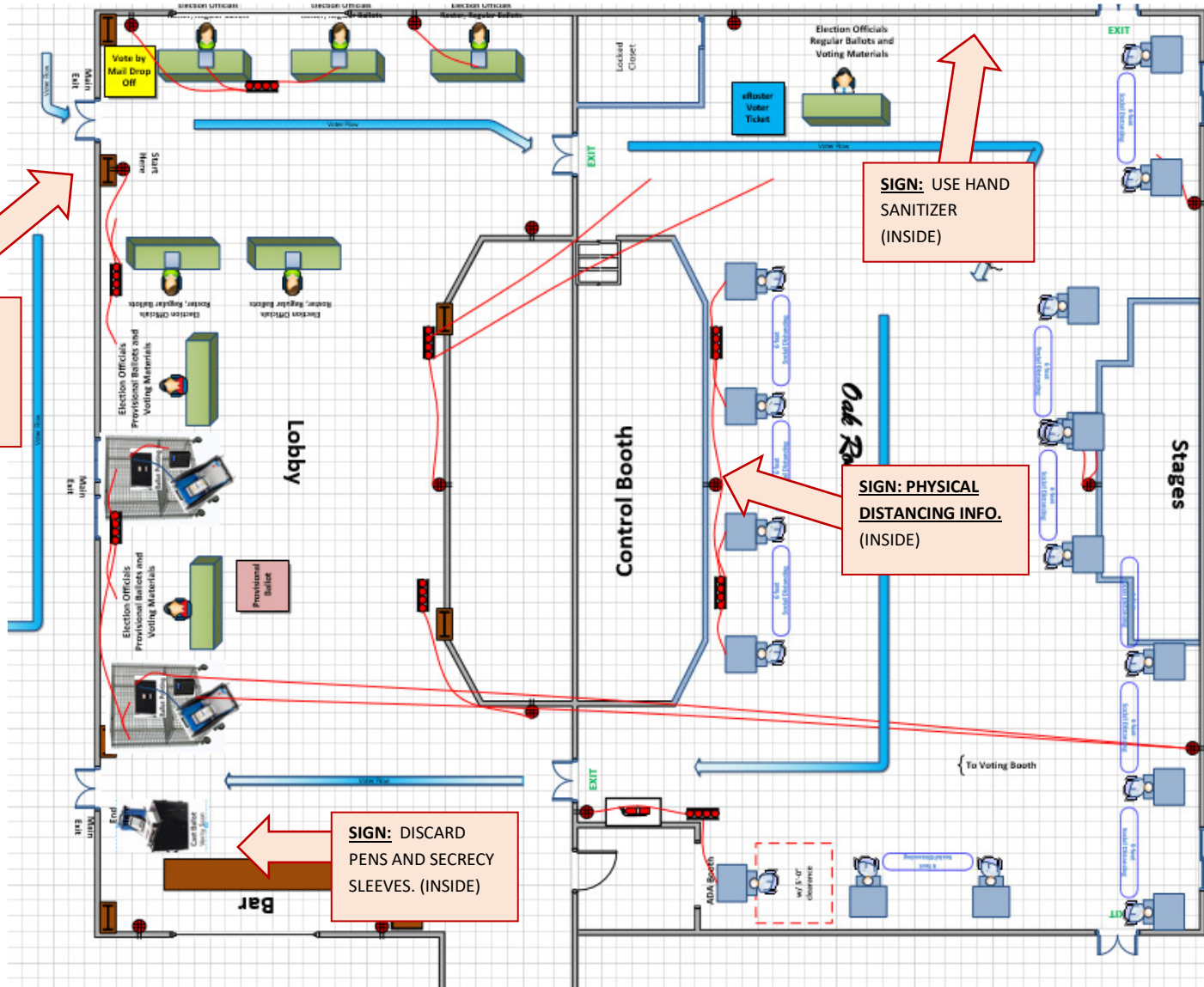

COVID-19 Prevention Action Plan – Poll Places



Vacaville – St. Josephs Parish



20x Social Distance Markers

**MAXIMUM
OCCUPANCY:
40**

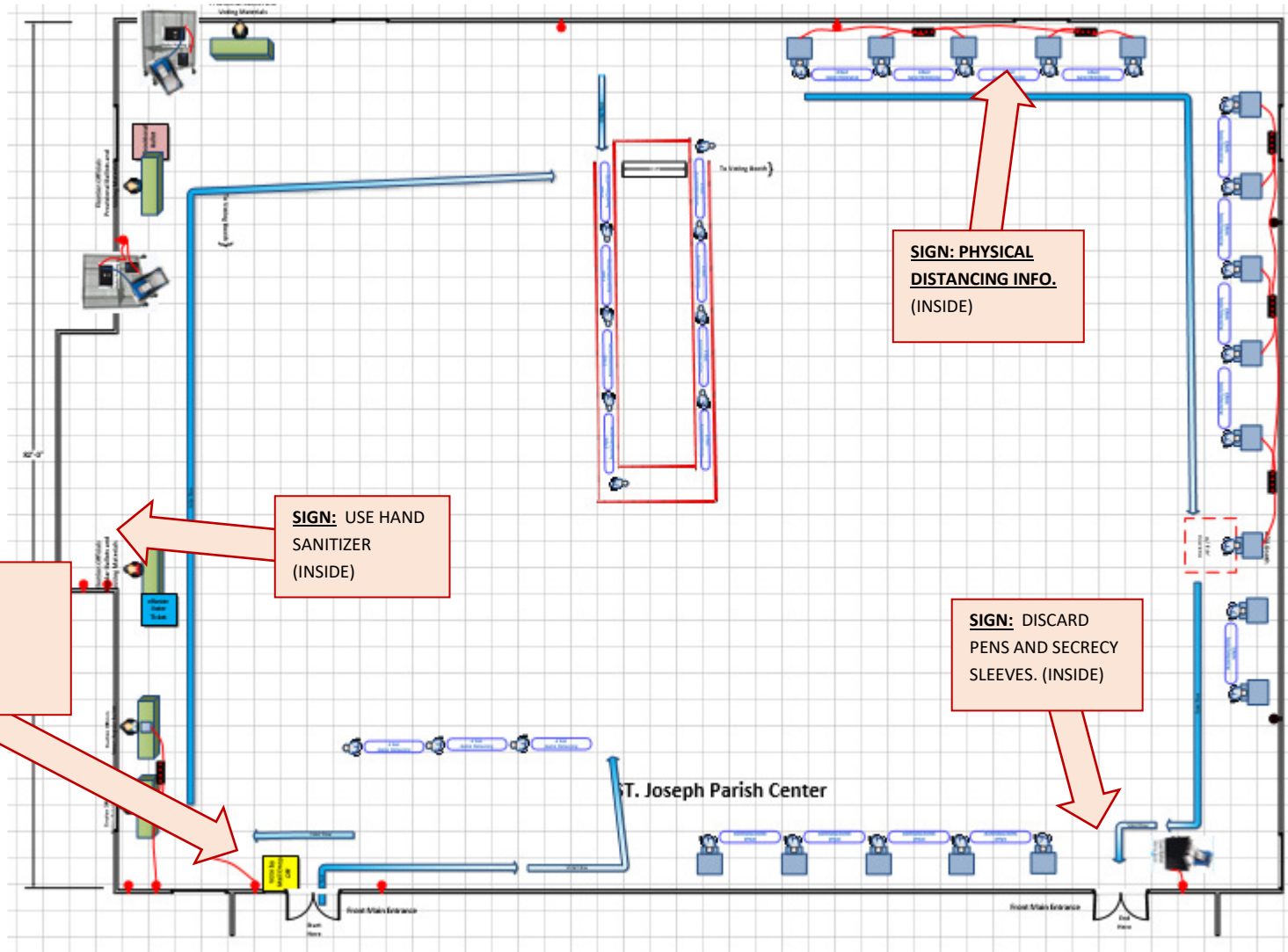

COVID-19 Prevention Action Plan – Poll Places



Vacaville – The Fathers House:



10x Social Distance Markers

MAXIMUM OCCUPANCY: 25

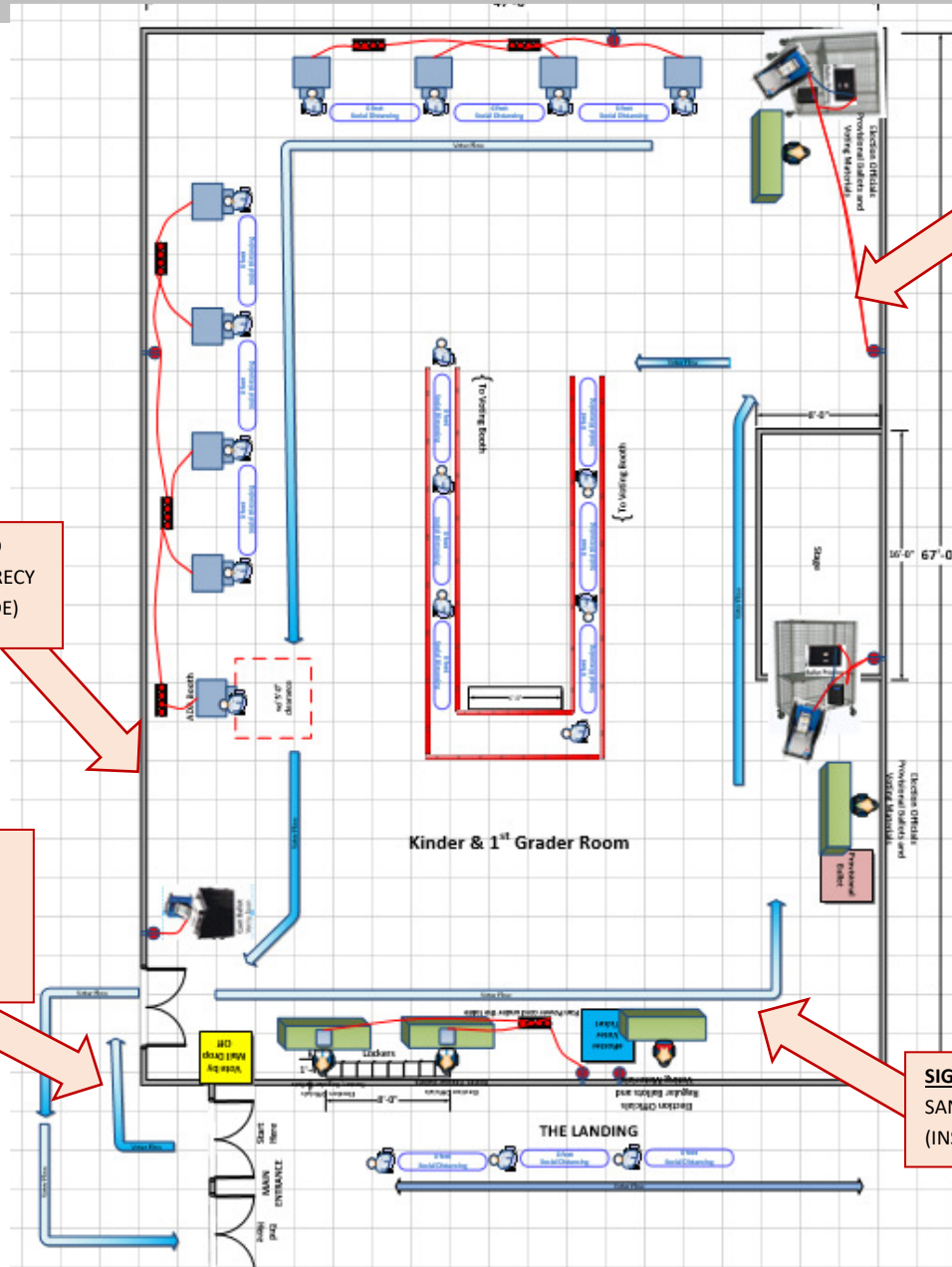

SIGN: PHYSICAL DISTANCING INFO. (INSIDE)

SIGN: DISCARD PENS AND SECRECY SLEEVES. (INSIDE)

SIGN (outside):
 1) MAXIMUM OCCUPANCY;
 2) USE HAND SANITIZER;
 3) PHYSICAL DISTANCING INFO;

SIGN: USE HAND SANITIZER (INSIDE)

SIGN: CURBSIDE VOTING AVAILABLE (OUTSIDE)

COVID-19 Prevention Action Plan – Poll Places



Vacaville – Thrive Church:



5x Social Distance Markers

MAXIMUM OCCUPANCY:
25

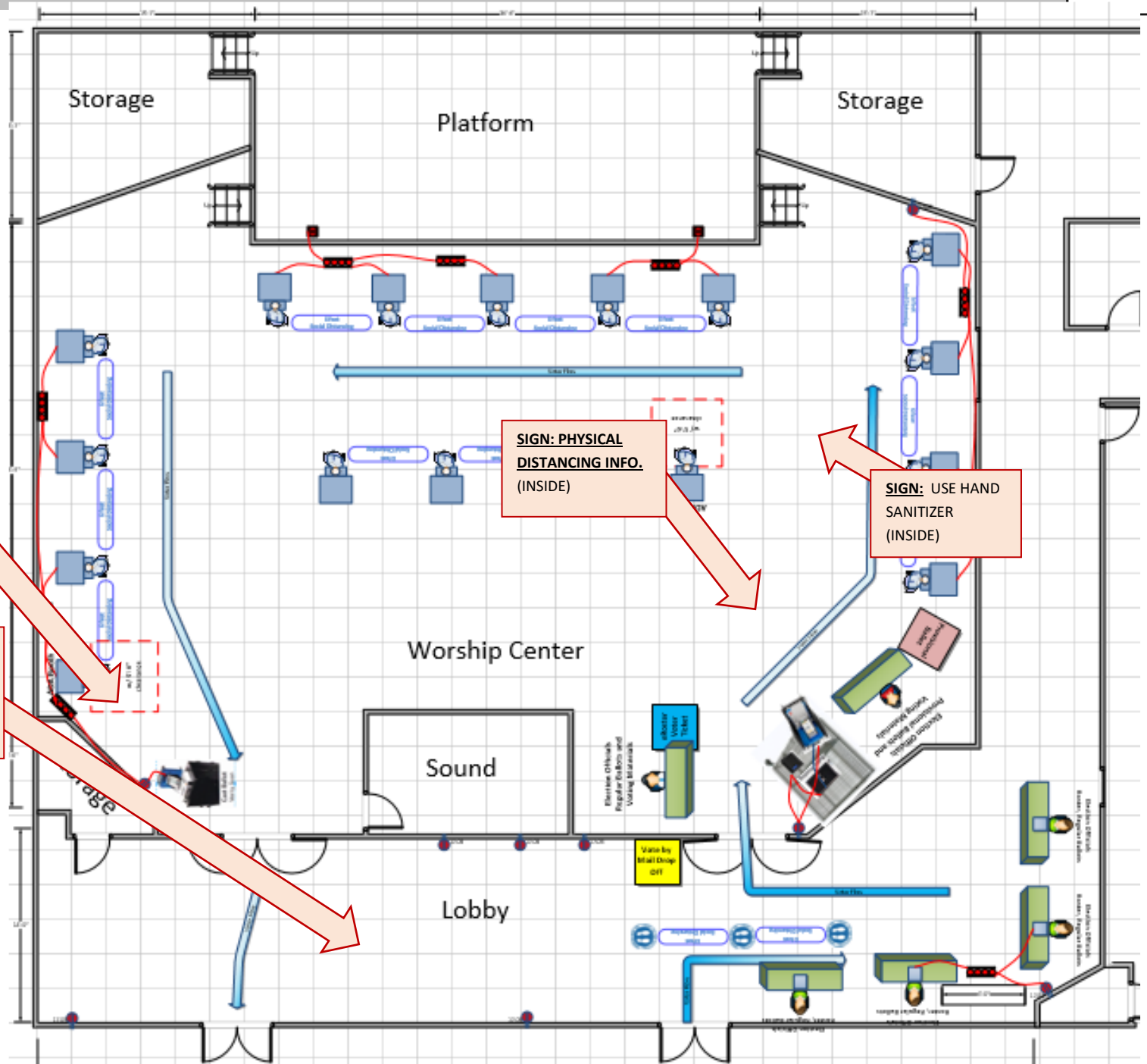

SIGN: DISCARD PENS AND SECRECY SLEEVES. (INSIDE)

SIGN: PHYSICAL DISTANCING INFO. (INSIDE)

SIGN: USE HAND SANITIZER (INSIDE)

SIGN (outside):
1) MAXIMUM OCCUPANCY;
2) USE HAND SANITIZER;
3) PHYSICAL DISTANCING INFO;

SIGN: CURBSIDE VOTING AVAILABLE (OUTSIDE)

COVID-19 Prevention Action Plan – Poll Places



Vacaville – Shiloh Baptist Church:

MAXIMUM OCCUPANCY:
35

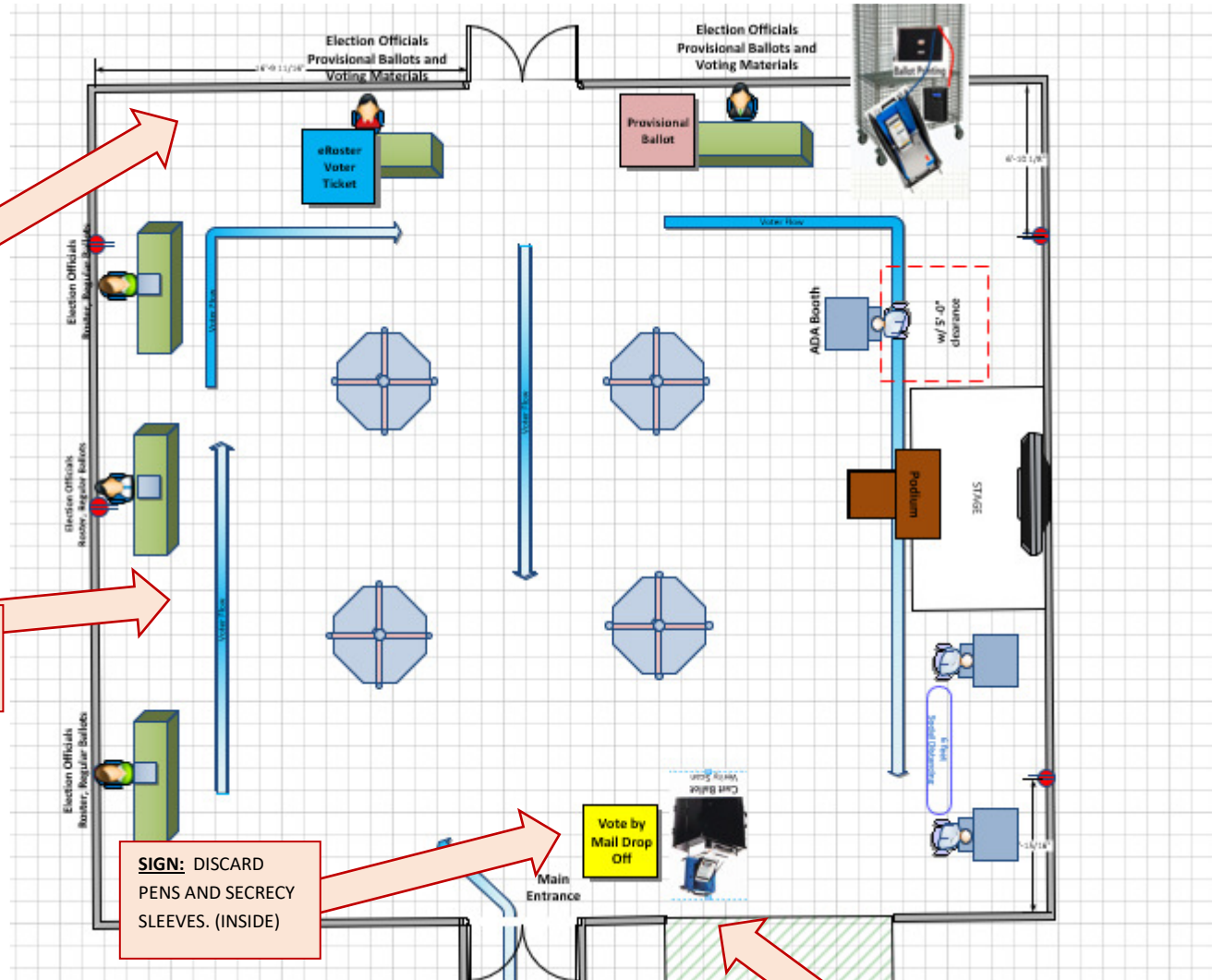

SIGN: PHYSICAL DISTANCING INFO.
(INSIDE)

SIGN: USE HAND SANITIZER
(INSIDE)

SIGN: DISCARD PENS AND SECRECY SLEEVES. (INSIDE)

SIGN: CURBSIDE VOTING AVAILABLE
(OUTSIDE)

SIGN (outside):
1) MAXIMUM OCCUPANCY;
2) USE HAND SANITIZER;
3) PHYSICAL DISTANCING INFO;

COVID-19 Prevention Action Plan – Poll Places



Vacaville – Ulatis Cultural Center

MAXIMUM OCCUPANCY:
20

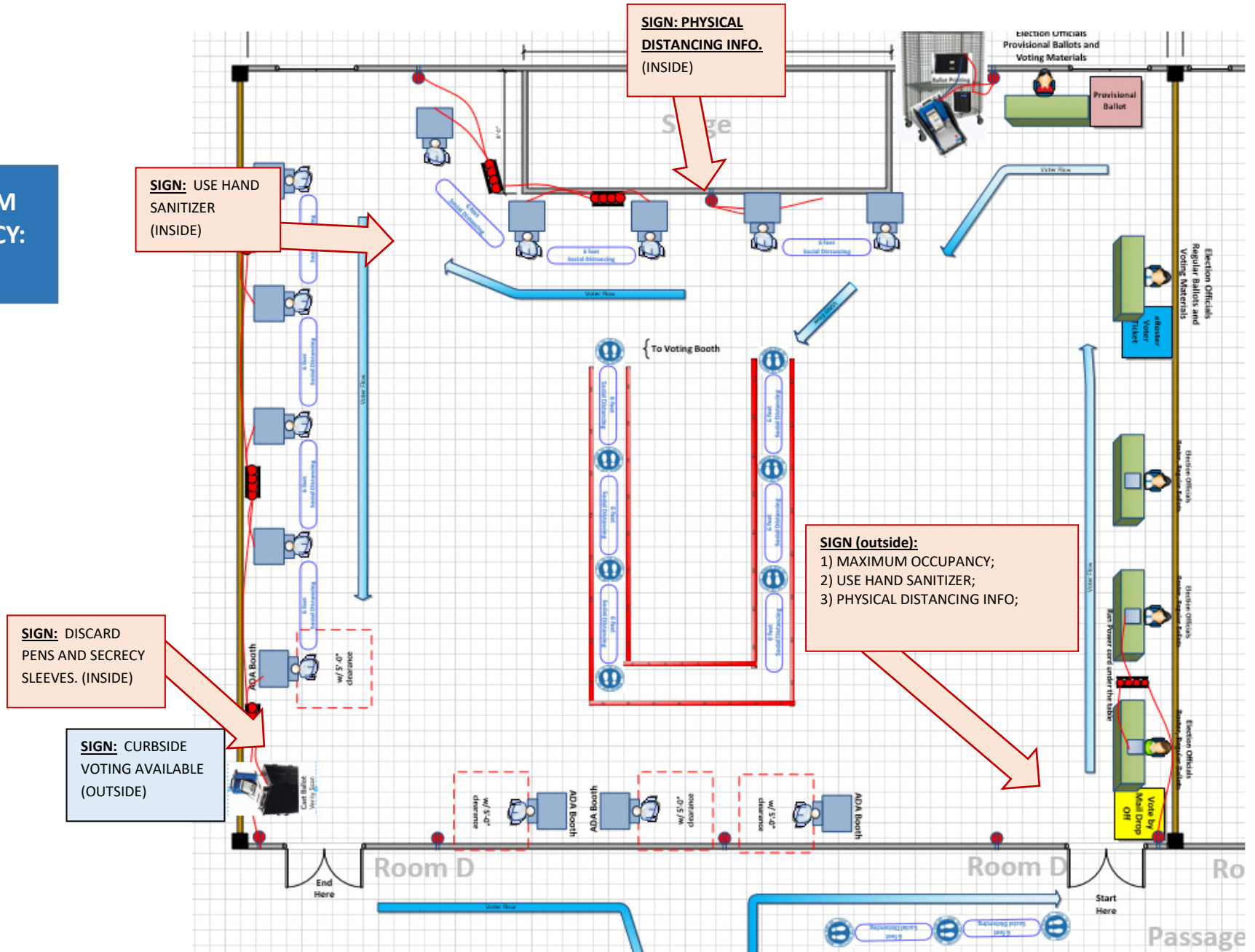

COVID-19 Prevention Action Plan – Poll Places



Vacaville – Vaca Pena Middle School

MAXIMUM OCCUPANCY:
20

SIGN: PHYSICAL DISTANCING INFO.
(INSIDE)

SIGN: USE HAND SANITIZER
(INSIDE)

SIGN (outside):
1) MAXIMUM OCCUPANCY;
2) USE HAND SANITIZER;
3) PHYSICAL DISTANCING INFO;

SIGN: CURBSIDE VOTING AVAILABLE
(OUTSIDE)

SIGN: DISCARD PENS AND SECRECY SLEEVES. (INSIDE)

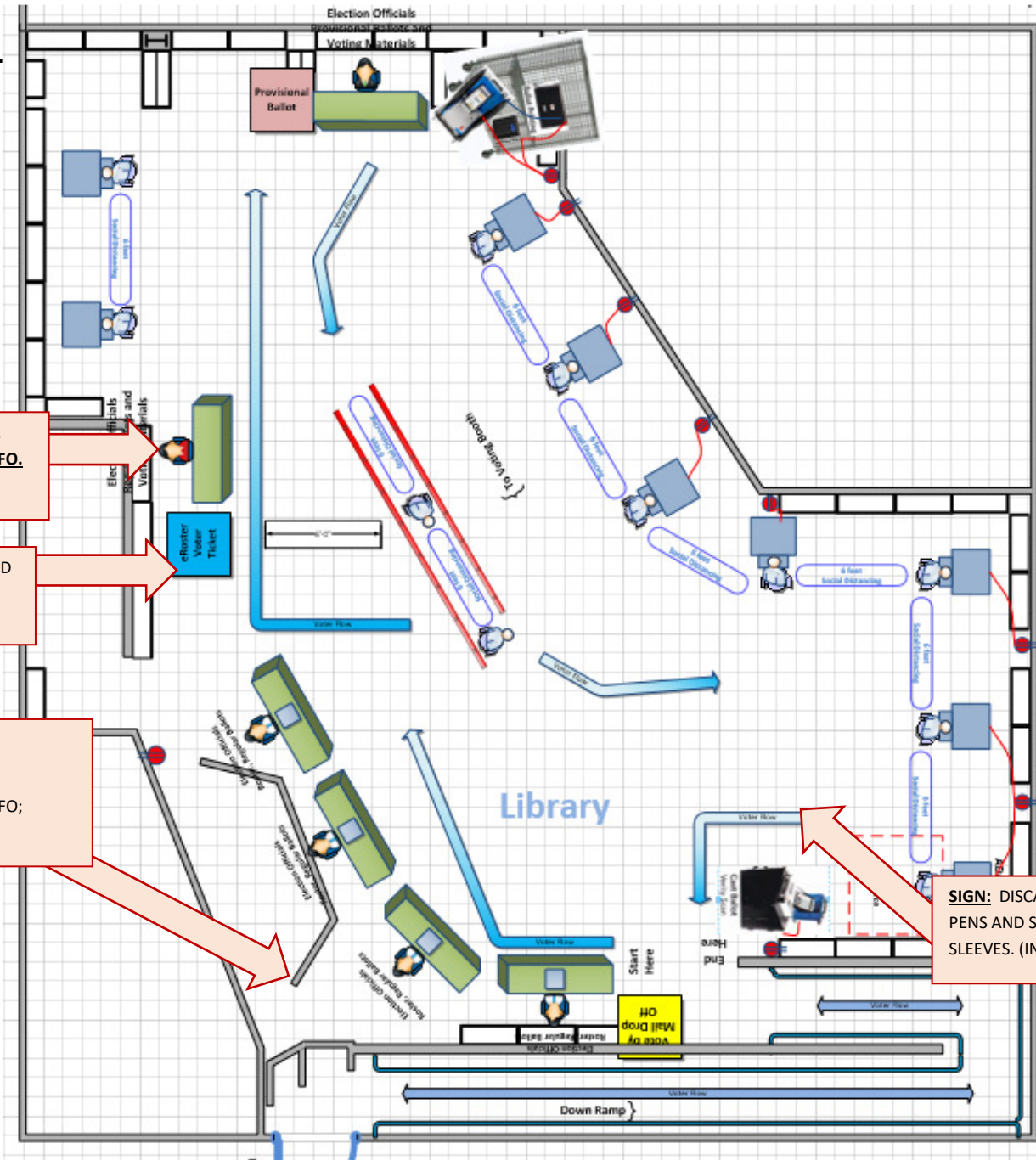

COVID-19 Prevention Action Plan – Poll Places



Vacaville – Community Presbyterian Church



5x Social Distance Markers

MAXIMUM OCCUPANCY:
15

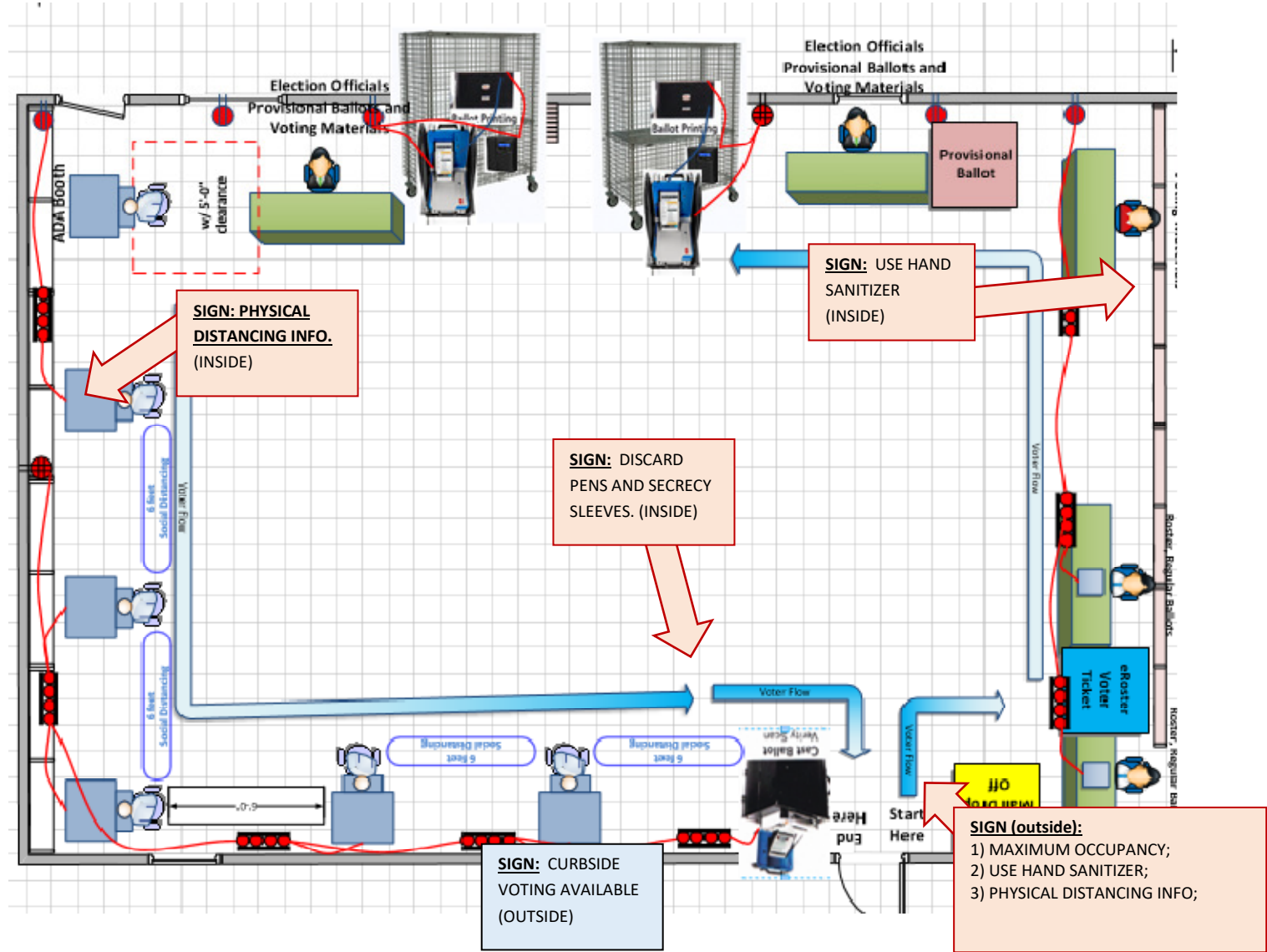

COVID-19 Prevention Action Plan – Poll Places



Vacaville - Fire Station 65:



10x Social Distance Markers

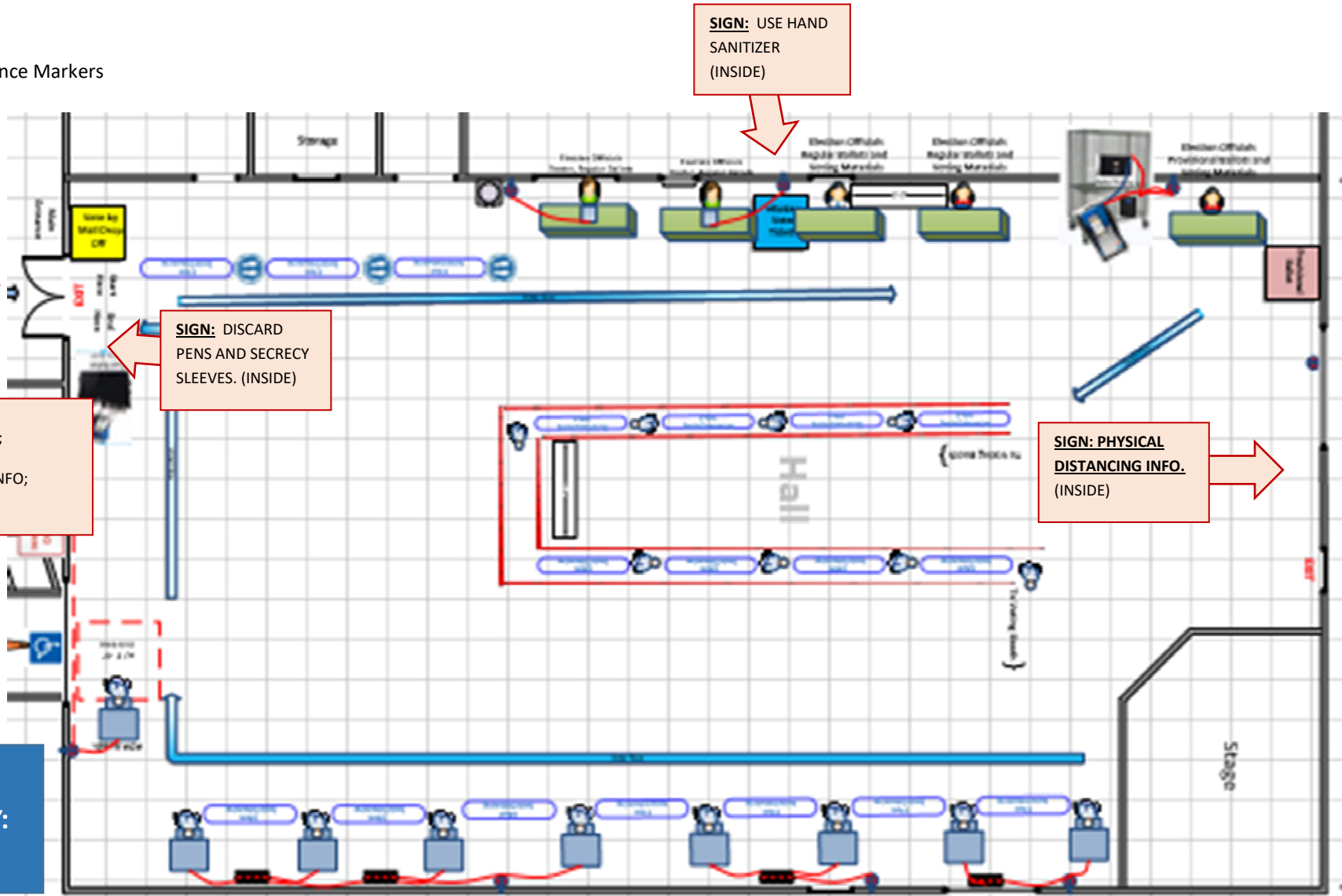

COVID-19 Prevention Action Plan – Poll Places



Vacaville – Seventh Day Adventist Church



10x Social Distance Markers

**MAXIMUM OCCUPANCY:
20**

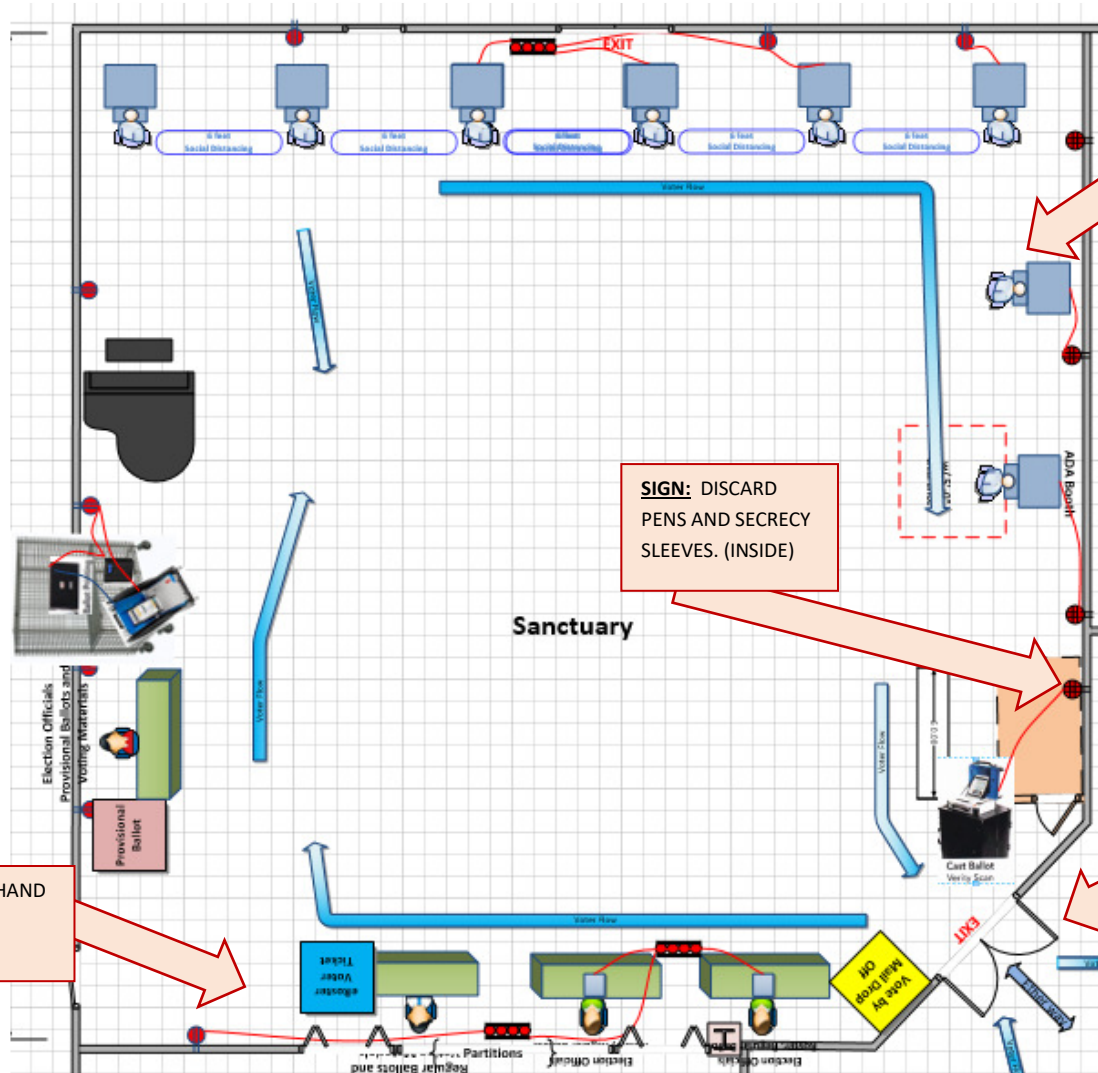

SIGN: PHYSICAL DISTANCING INFO. (INSIDE)

SIGN: DISCARD PENS AND SECRECY SLEEVES. (INSIDE)

SIGN (outside):
1) MAXIMUM OCCUPANCY;
2) USE HAND SANITIZER;
3) PHYSICAL DISTANCING INFO;
4) FACE COVERINGS INFO.

SIGN: USE HAND SANITIZER (INSIDE)

SIGN: CURBSIDE VOTING AVAILABLE (OUTSIDE)

COVID-19 Prevention Action Plan – Poll Places



Vallejo – First Presbyterian Church:



10x Social Distance Markers

MAXIMUM OCCUPANCY: 10

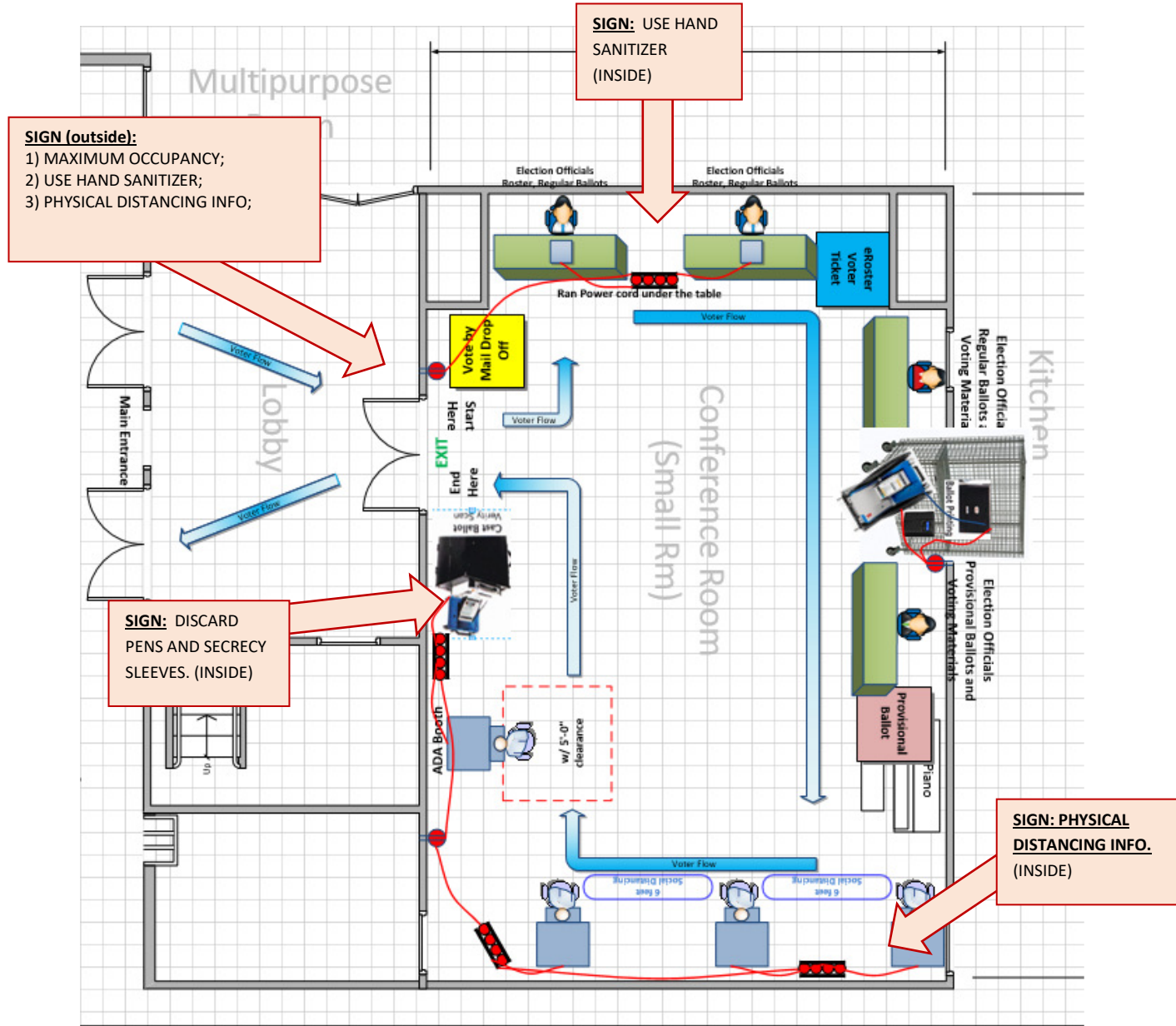

COVID-19 Prevention Action Plan – Poll Places



Vallejo – In-Shape Vallejo



10x Social Distance Markers

MAXIMUM OCCUPANCY: 10

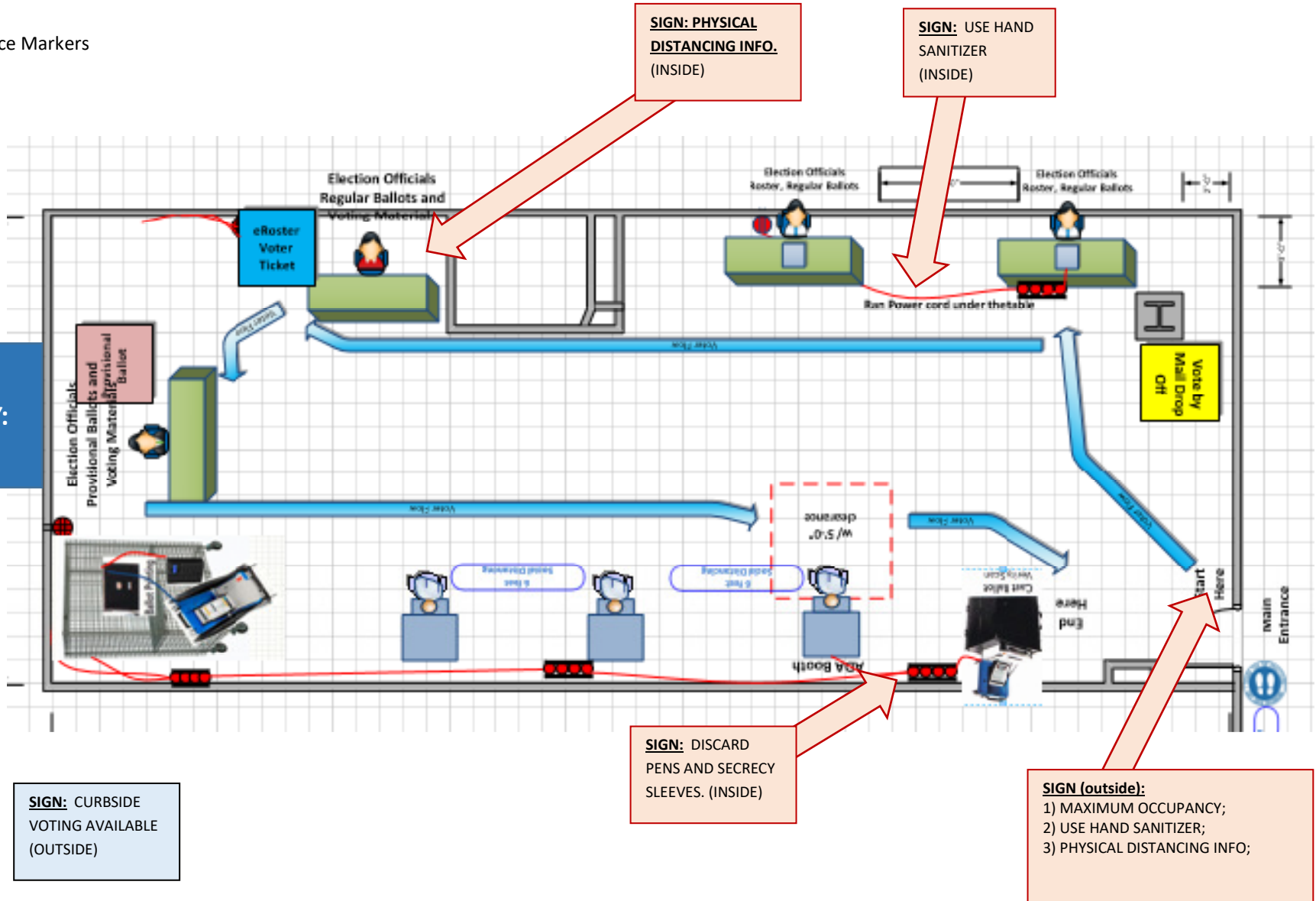

COVID-19 Prevention Action Plan – Poll Places



Vallejo – Community Presbyterian Church



10x Social Distance Markers

MAXIMUM OCCUPANCY: 15

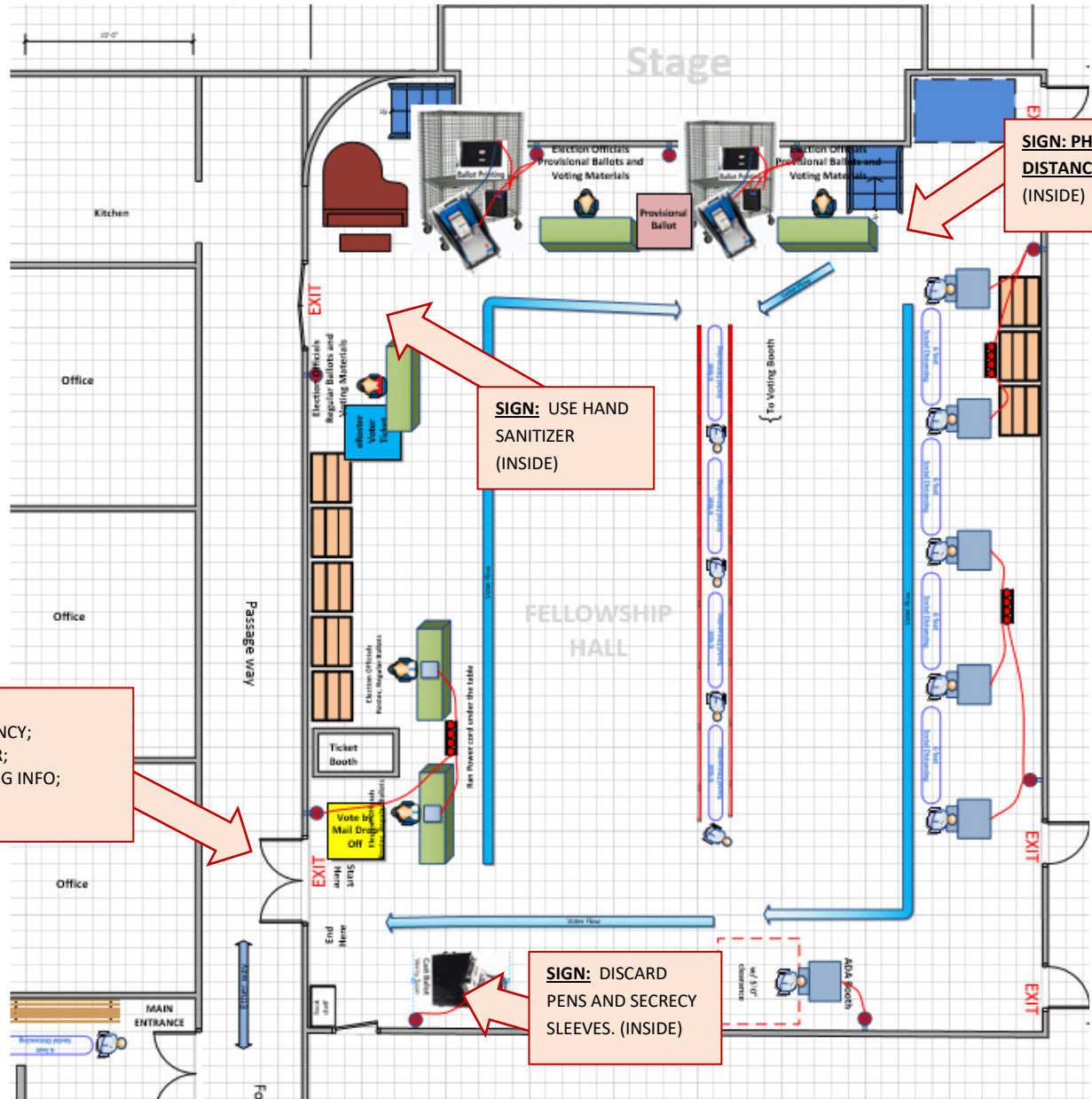

SIGN (outside):
 1) MAXIMUM OCCUPANCY;
 2) USE HAND SANITIZER;
 3) PHYSICAL DISTANCING INFO;

SIGN: CURBSIDE VOTING AVAILABLE (OUTSIDE)

SIGN: USE HAND SANITIZER (INSIDE)

SIGN: PHYSICAL DISTANCING INFO. (INSIDE)

SIGN: DISCARD PENS AND SECRECY SLEEVES. (INSIDE)

COVID-19 Prevention Action Plan – Poll Places



Vallejo – Fellowship United Methodist Church



10x Social Distance Markers

MAXIMUM OCCUPANCY:
15

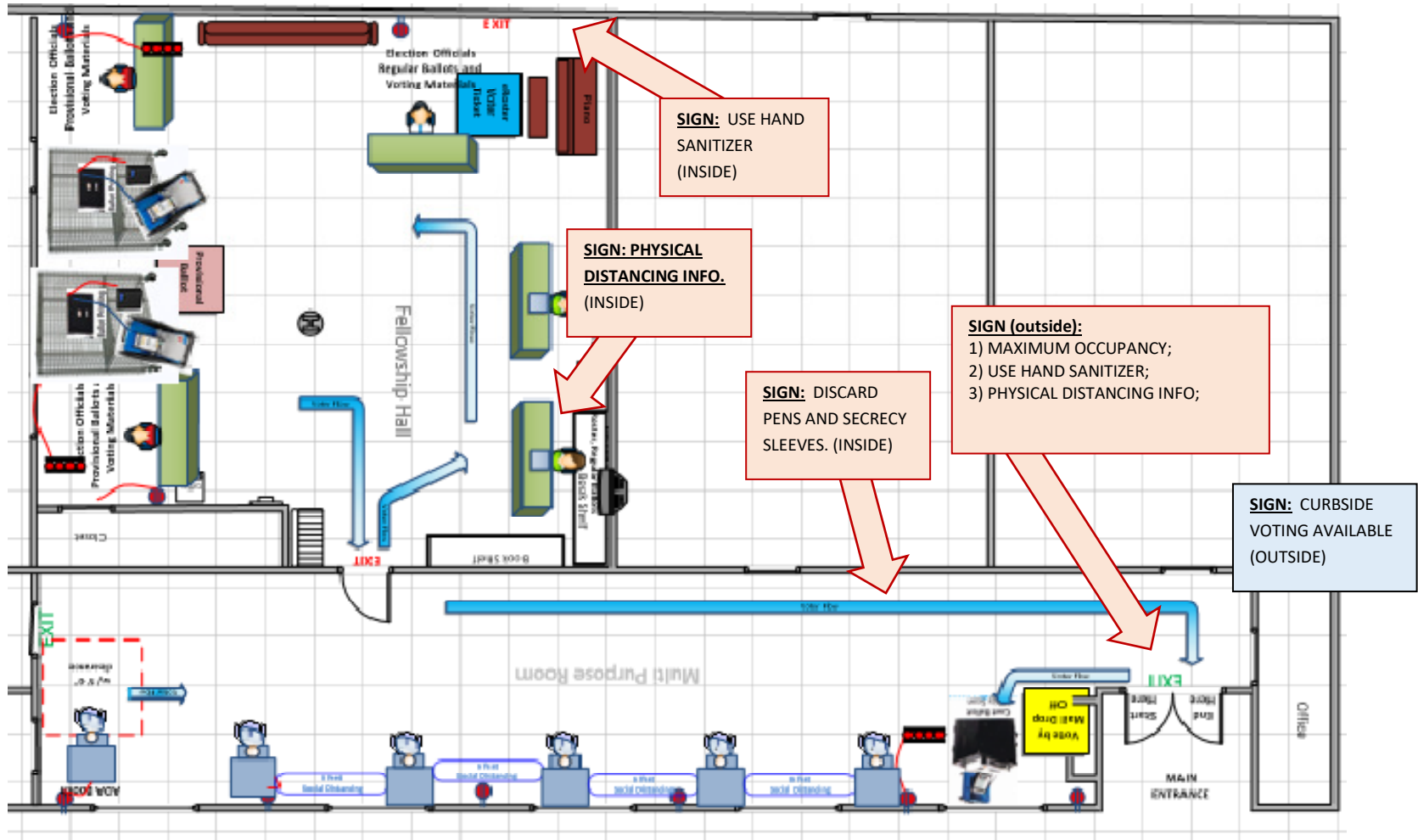

COVID-19 Prevention Action Plan – Poll Places



Vallejo – Filipino Cultural Center – Banquet Hall



15x Social Distance Markers

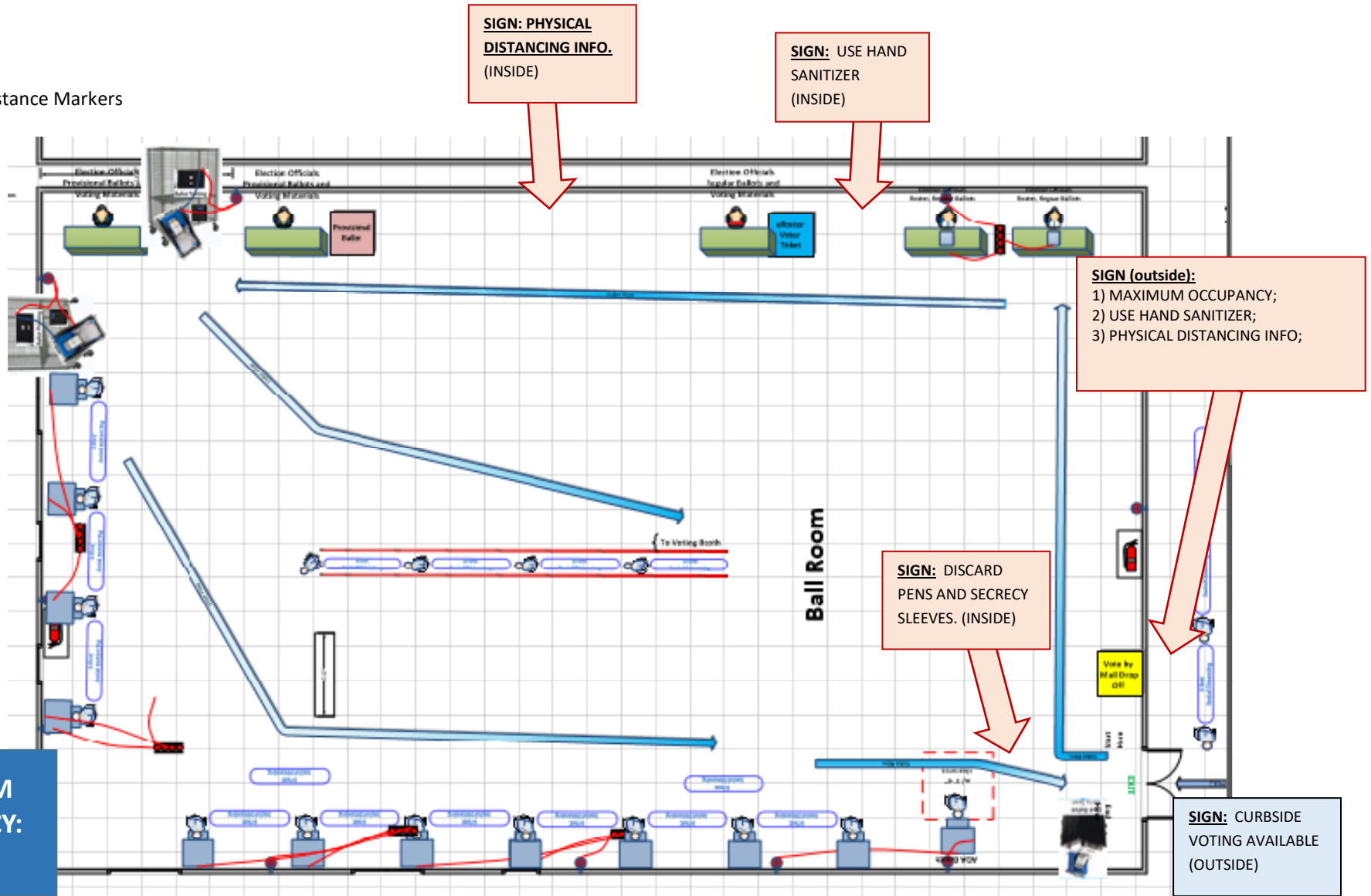

COVID-19 Prevention Action Plan – Poll Places



Vallejo – Friendship Baptist Church



10x Social Distance Markers

**MAXIMUM OCCUPANCY:
15**

SIGN (outside):
1) MAXIMUM OCCUPANCY;
2) USE HAND SANITIZER;
3) PHYSICAL DISTANCING INFO;

SIGN: CURBSIDE VOTING AVAILABLE (OUTSIDE)

SIGN: PHYSICAL DISTANCING INFO. (INSIDE)

SIGN: DISCARD PENS AND SECRECY SLEEVES. (INSIDE)

SIGN: USE HAND SANITIZER (INSIDE)

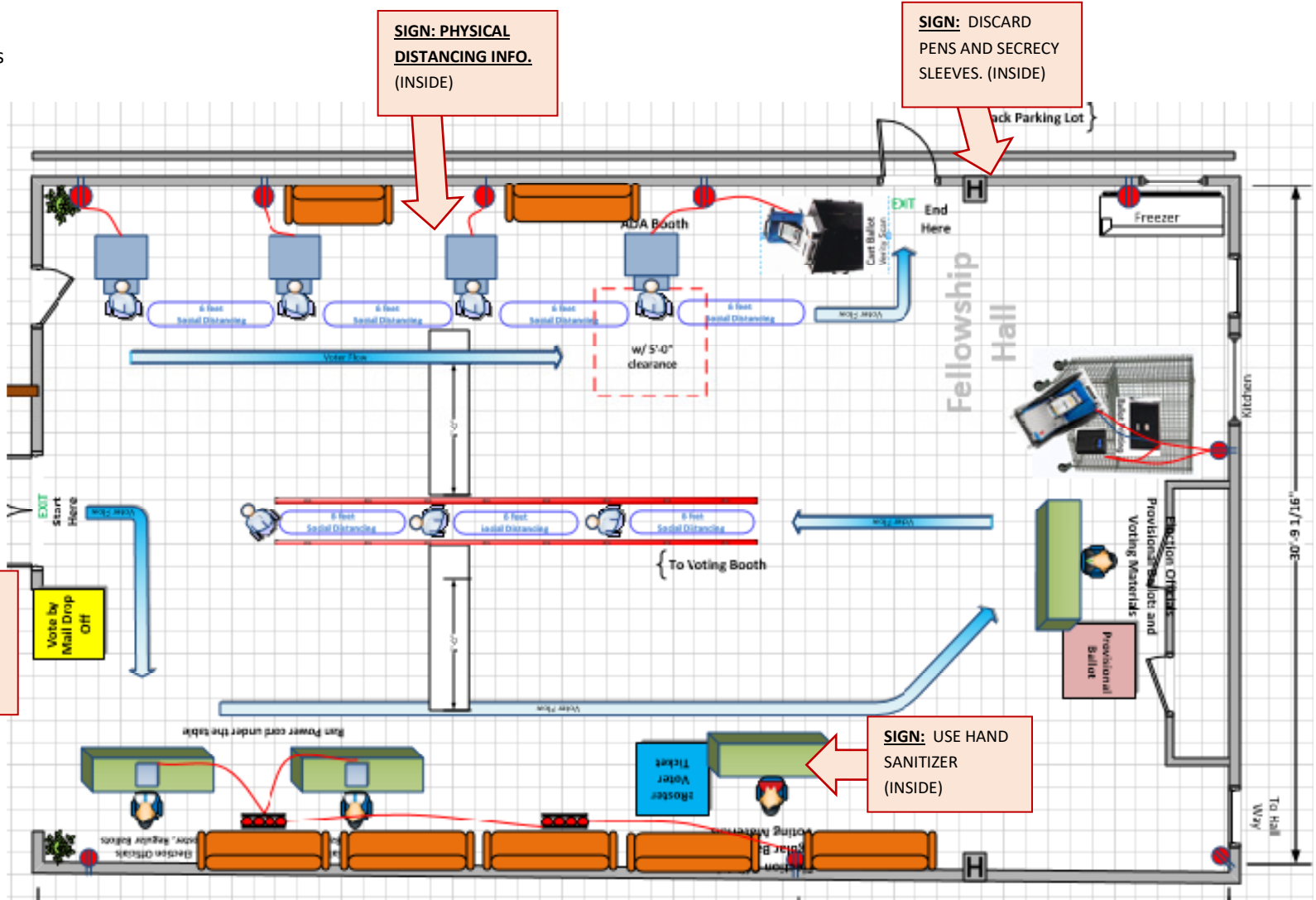

COVID-19 Prevention Action Plan – Poll Places



Vallejo – Hiddenbrooke Golf Club



10x Social Distance Markers

MAXIMUM OCCUPANCY:
15

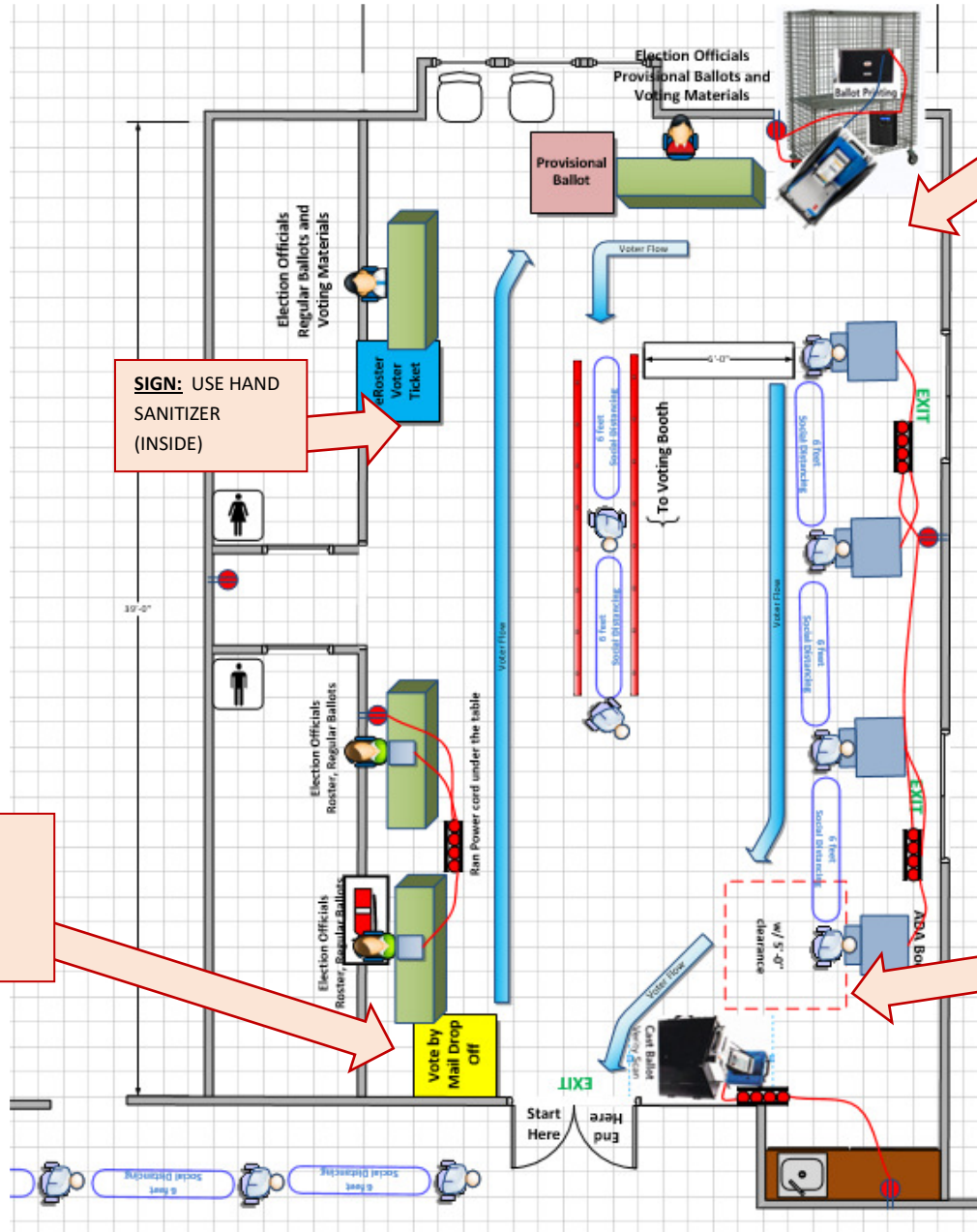

SIGN: USE HAND SANITIZER (INSIDE)

SIGN: PHYSICAL DISTANCING INFO. (INSIDE)

SIGN (outside):
1) MAXIMUM OCCUPANCY;
2) USE HAND SANITIZER;
3) PHYSICAL DISTANCING INFO;

SIGN: DISCARD PENS AND SECRECY SLEEVES. (INSIDE)

SIGN: CURBSIDE VOTING AVAILABLE (OUTSIDE)

COVID-19 Prevention Action Plan – Poll Places



Vallejo – The Lighthouse at Glen Cove:



5x Social Distance Markers

MAXIMUM OCCUPANCY: 20

SIGN: CURBSIDE VOTING AVAILABLE (OUTSIDE)

SIGN (outside):
1) MAXIMUM OCCUPANCY;
2) USE HAND SANITIZER;
3) PHYSICAL DISTANCING INFO;

SIGN: PHYSICAL DISTANCING INFO. (INSIDE)

SIGN: DISCARD PENS AND SECRECY SLEEVES. (INSIDE)

SIGN: USE HAND SANITIZER (INSIDE)

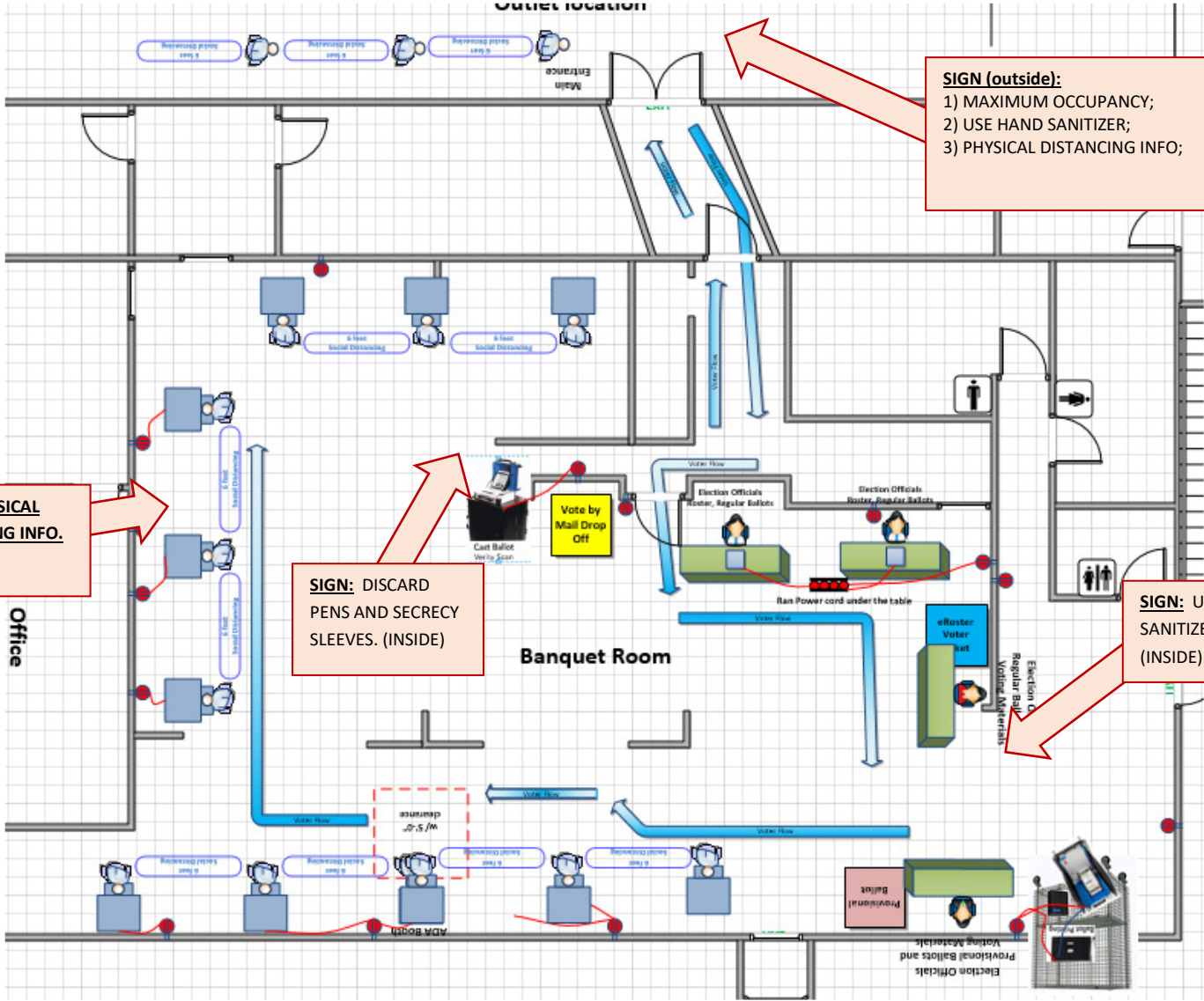

COVID-19 Prevention Action Plan – Poll Places



Vallejo – Masonic Temple



10x Social Distance Markers

MAXIMUM OCCUPANCY: 30

SIGN: PHYSICAL DISTANCING INFO. (INSIDE)

SIGN (outside):

- 1) MAXIMUM OCCUPANCY;
- 2) USE HAND SANITIZER;
- 3) PHYSICAL DISTANCING INFO;

SIGN: USE HAND SANITIZER (INSIDE)

SIGN: CURBSIDE VOTING AVAILABLE (OUTSIDE)

SIGN: DISCARD PENS AND SECRECY SLEEVES. (INSIDE)

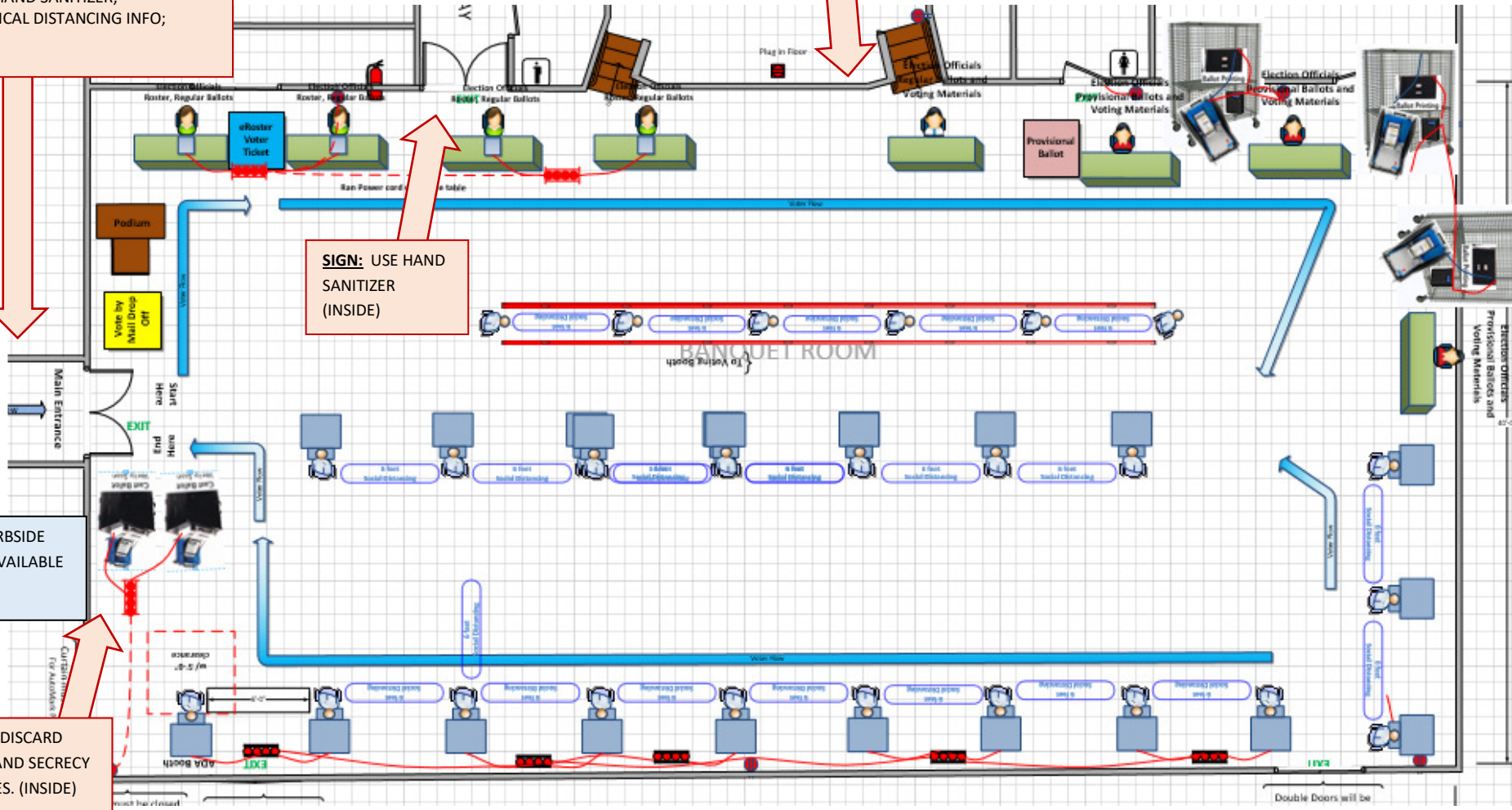

COVID-19 Prevention Action Plan – Poll Places



Vallejo – Norman C. King Community Center



10x Social Distance Markers

MAXIMUM OCCUPANCY:
5

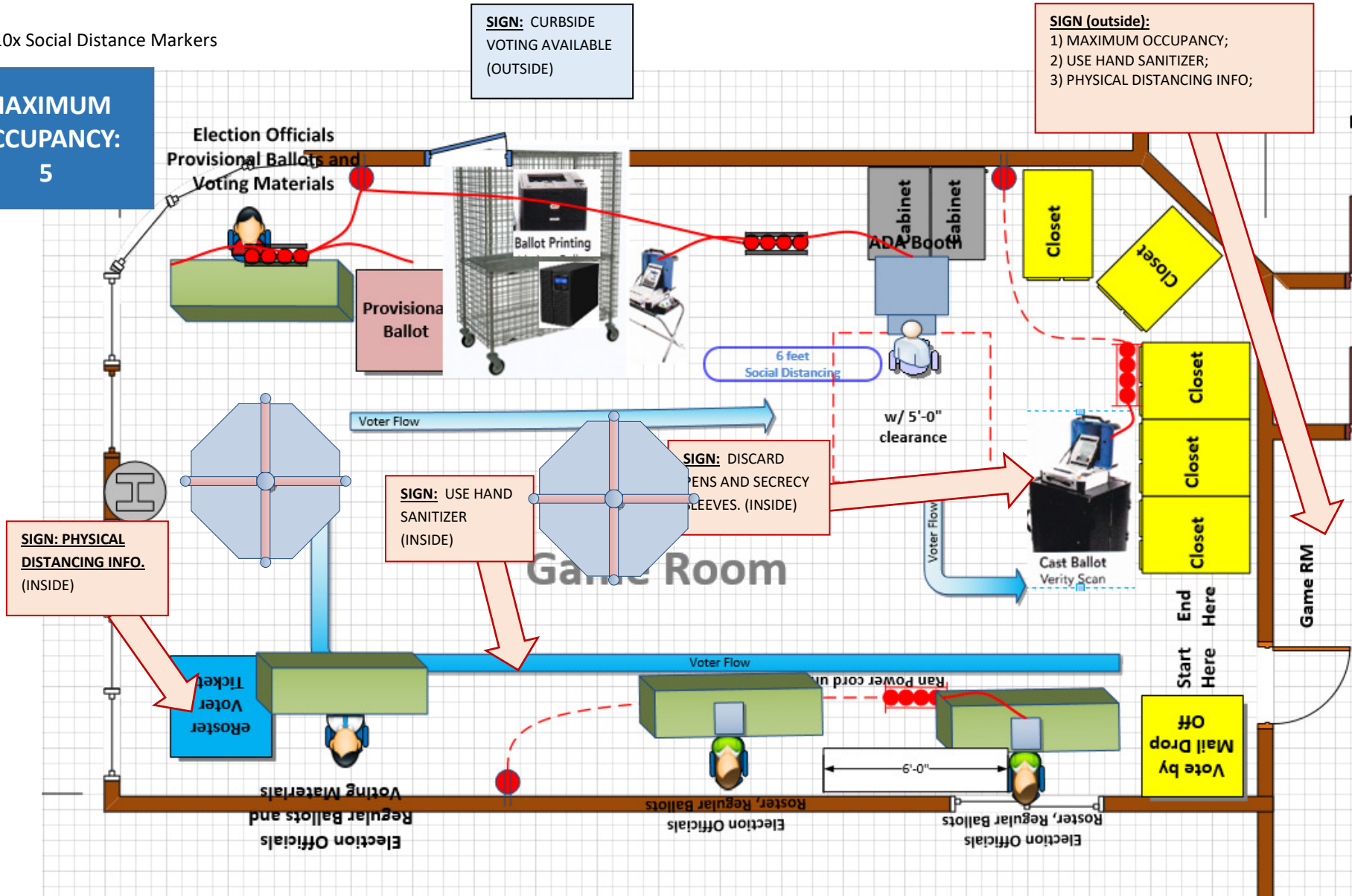

COVID-19 Prevention Action Plan – Poll Places



Vallejo – North Vallejo Community Center



10x Social Distance Markers

MAXIMUM OCCUPANCY:
15

SIGN: DISCARD PENS AND SECRECY SLEEVES. (INSIDE)

SIGN: PHYSICAL DISTANCING INFO. (INSIDE)

SIGN (outside):
1) MAXIMUM OCCUPANCY;
2) USE HAND SANITIZER;
3) PHYSICAL DISTANCING INFO;

SIGN: USE HAND SANITIZER (INSIDE)

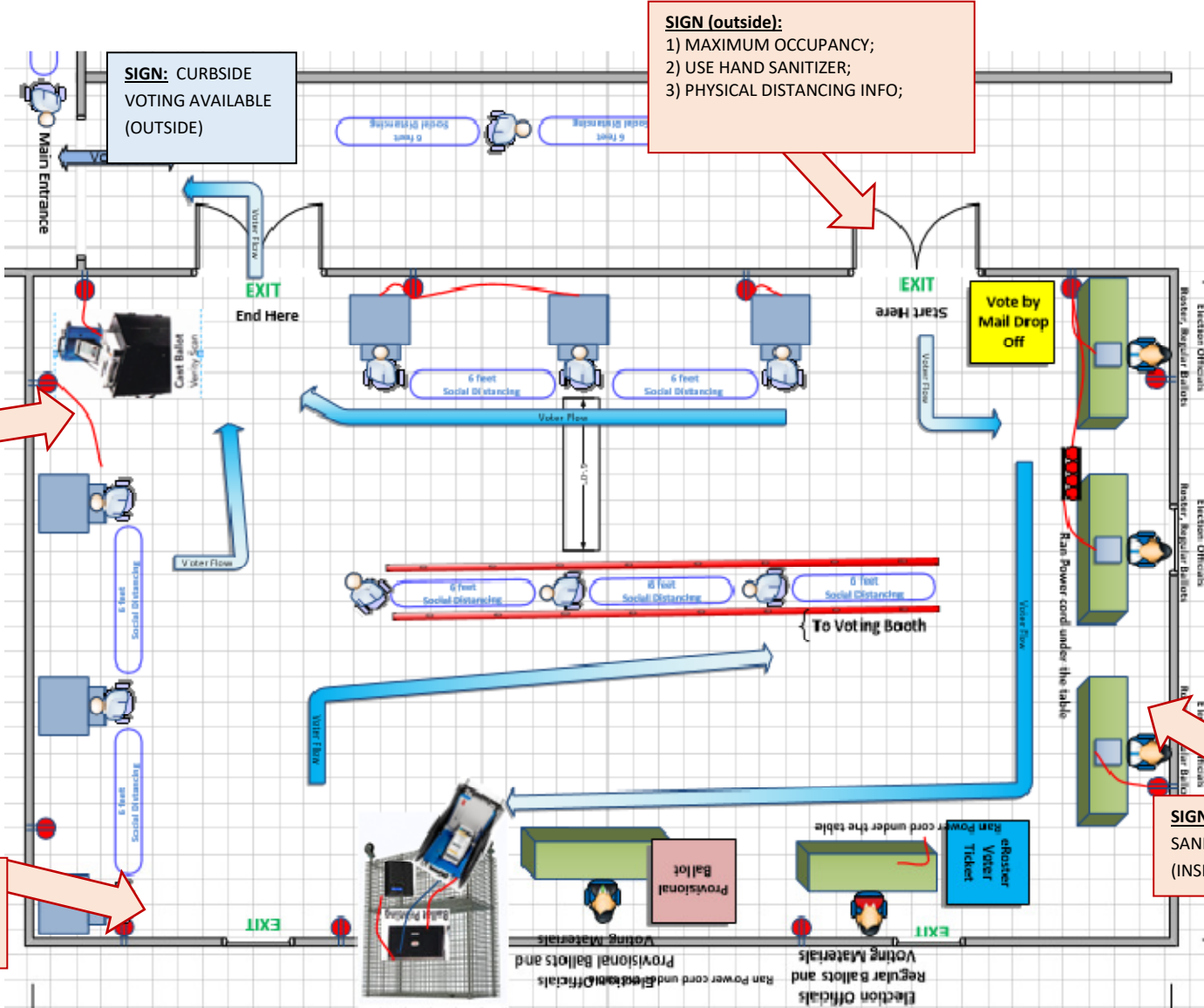

COVID-19 Prevention Action Plan – Poll Places



Vallejo – Second Baptist Church



10x Social Distance Markers

SIGN (outside):
 1) MAXIMUM OCCUPANCY;
 2) USE HAND SANITIZER;
 3) PHYSICAL DISTANCING INFO;

MAXIMUM OCCUPANCY: 15

SIGN: CURBSIDE VOTING AVAILABLE (OUTSIDE)

SIGN: DISCARD PENS AND SECRECY SLEEVES. (INSIDE)

SIGN: PHYSICAL DISTANCING INFO. (INSIDE)

SIGN: USE HAND SANITIZER (INSIDE)

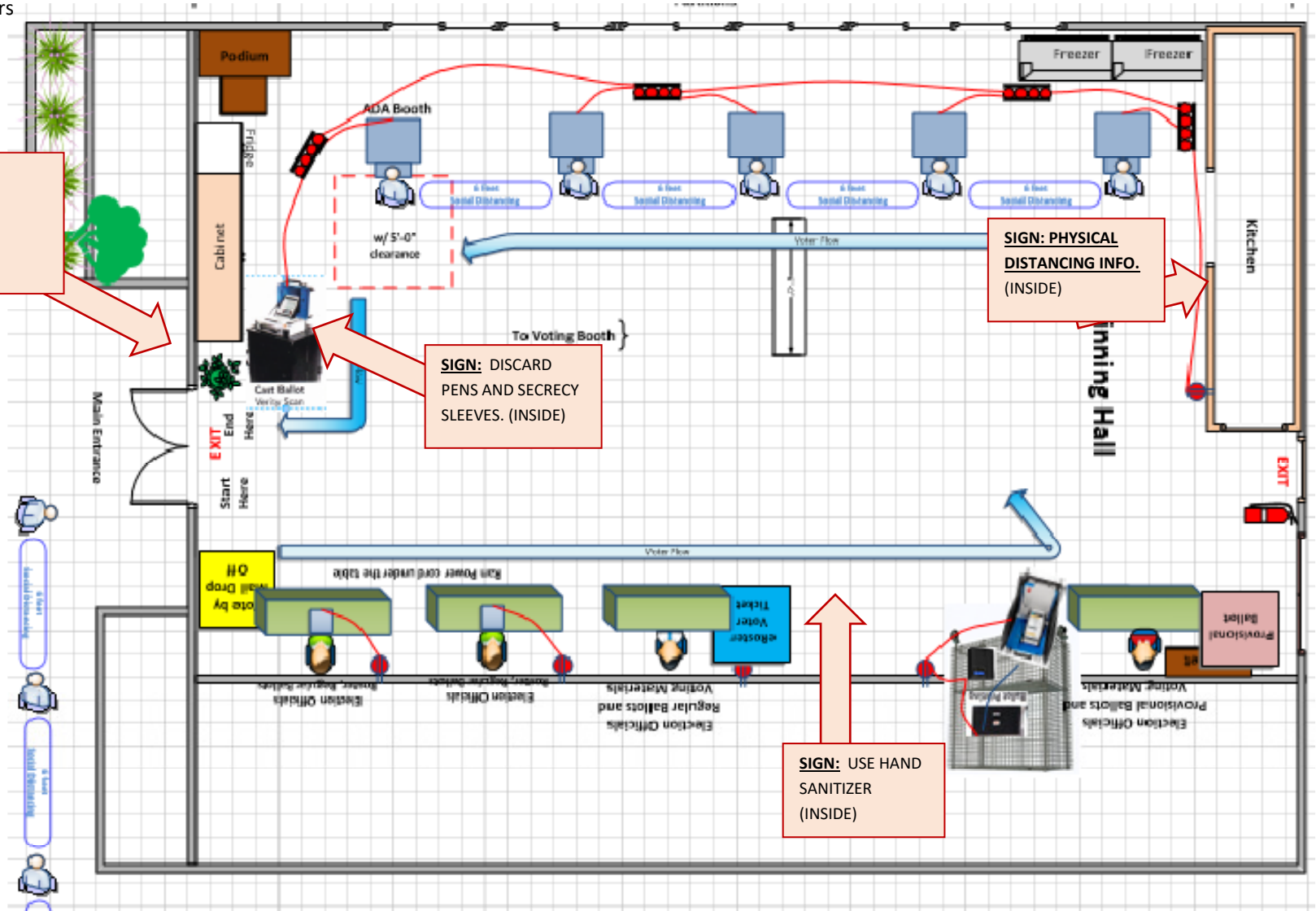

COVID-19 Prevention Action Plan – Poll Places



Vallejo – Solano Community College – Auto Tech. Center



10x Social Distance Markers

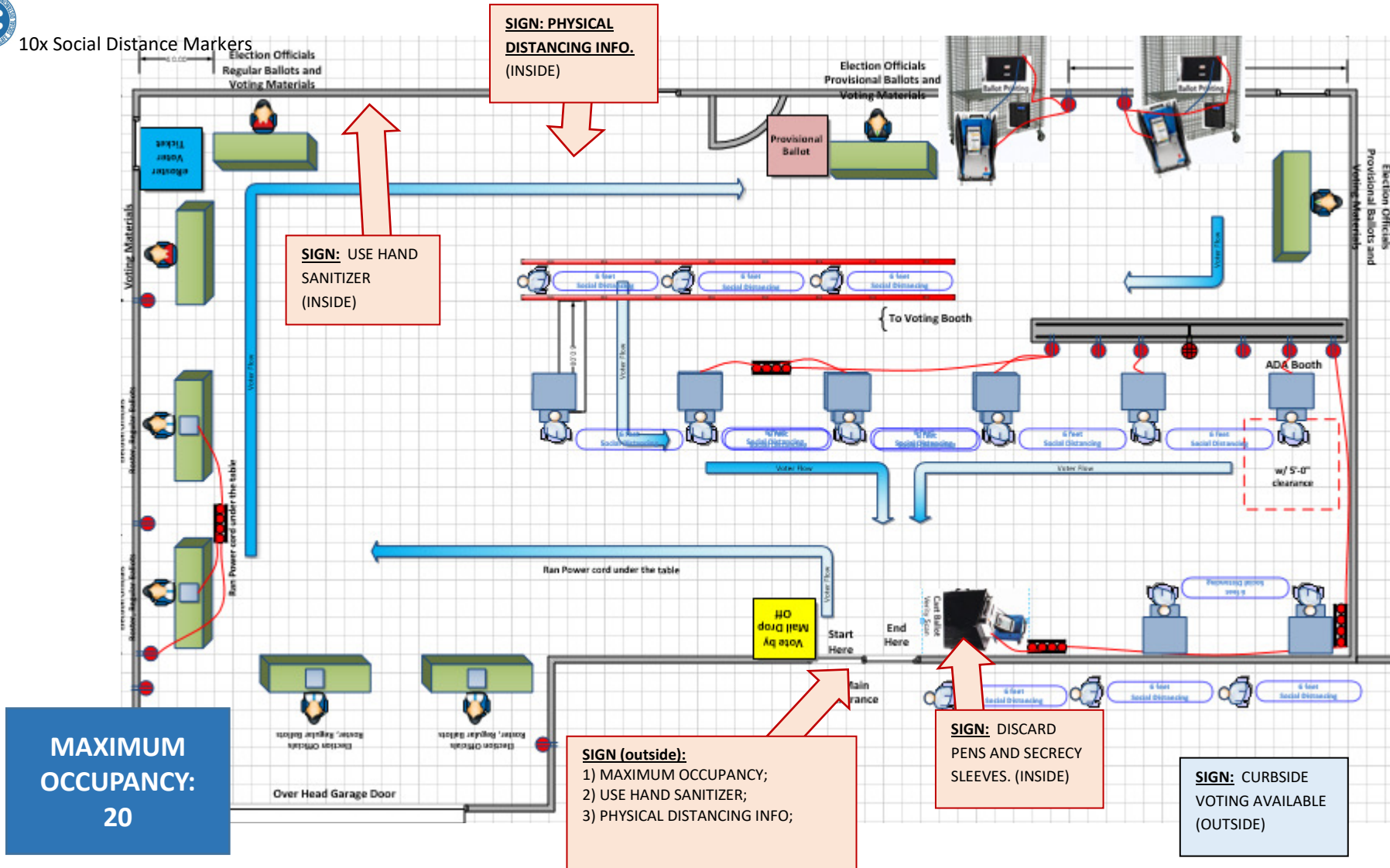

COVID-19 Prevention Action Plan – Poll Places



Vallejo – Solano County Fairgrounds:



20x Social Distance Markers

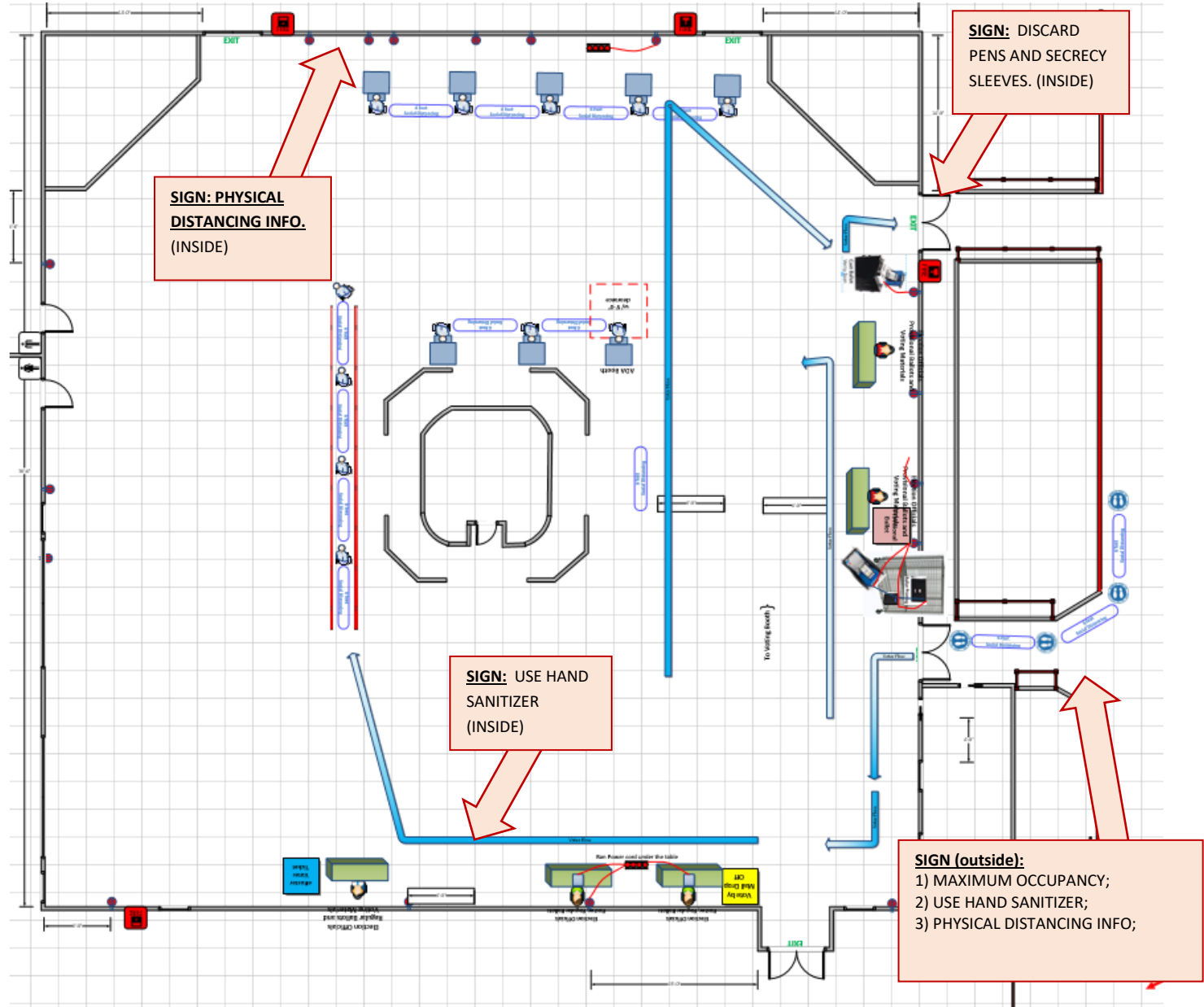

MAXIMUM OCCUPANCY:
30

SIGN: CURBSIDE VOTING AVAILABLE (OUTSIDE)

SIGN (outside):
1) MAXIMUM OCCUPANCY;
2) USE HAND SANITIZER;
3) PHYSICAL DISTANCING INFO;

COVID-19 Prevention Action Plan – Poll Places



Vallejo – St. Catherine of Siena:



5x Social Distance Markers

MAXIMUM OCCUPANCY:
15

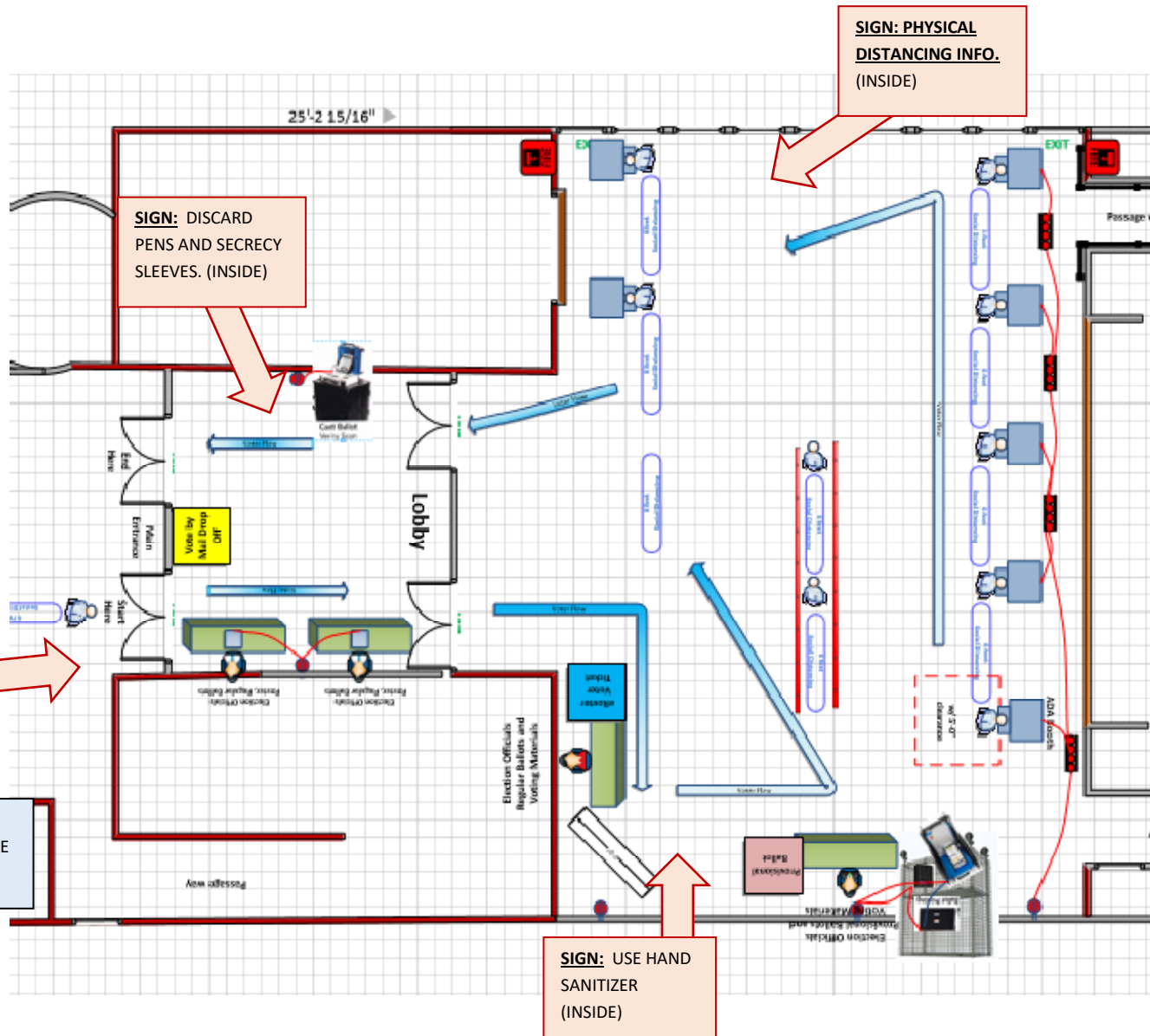

COVID-19 Prevention Action Plan – Poll Places



Vallejo – Union Baptist Church



10x Social Distance Markers

MAXIMUM OCCUPANCY:
15

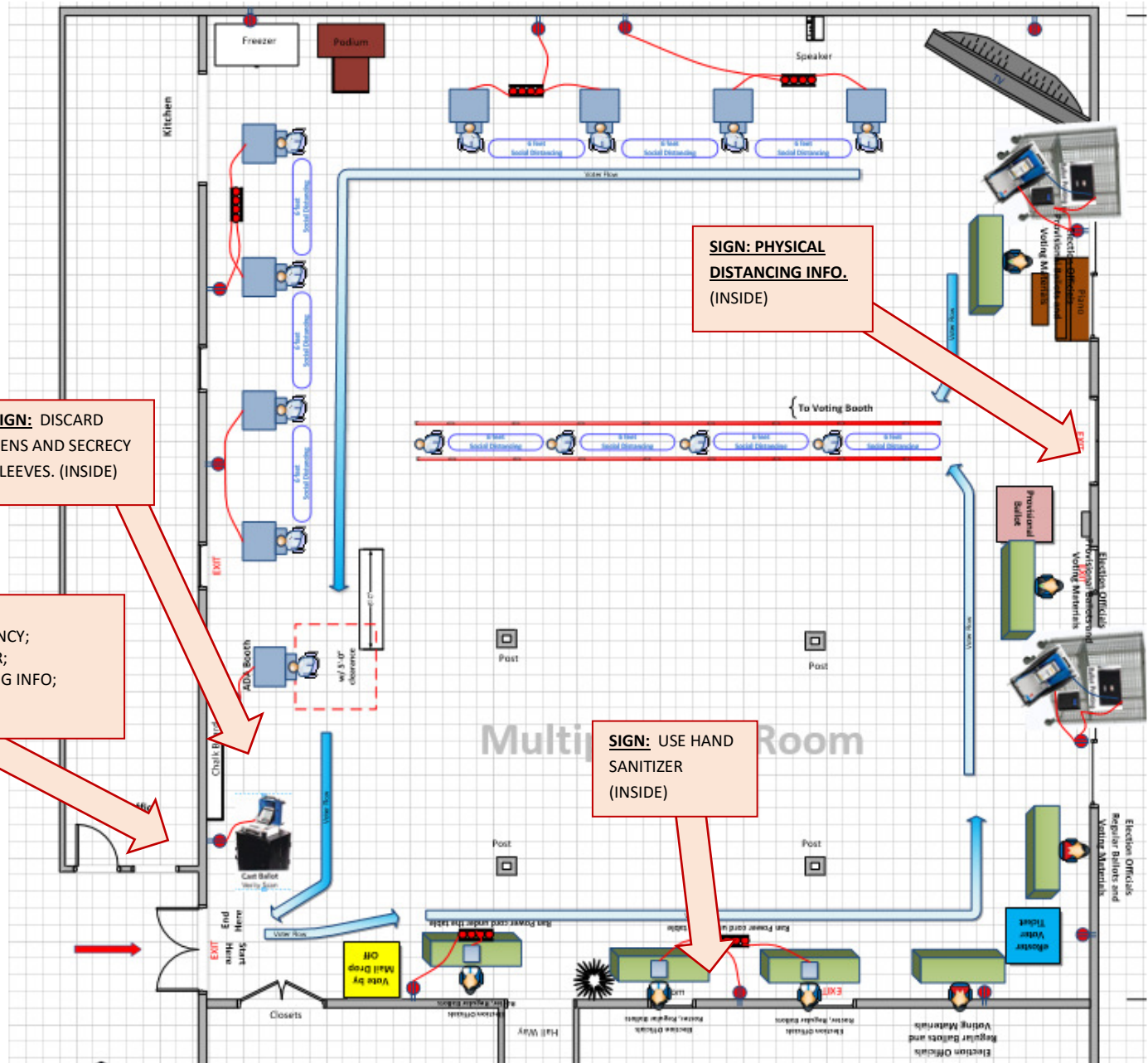

SIGN: DISCARD PENS AND SECRECY SLEEVES. (INSIDE)

SIGN: PHYSICAL DISTANCING INFO. (INSIDE)

SIGN (outside):
1) MAXIMUM OCCUPANCY;
2) USE HAND SANITIZER;
3) PHYSICAL DISTANCING INFO;

SIGN: USE HAND SANITIZER (INSIDE)

SIGN: CURBSIDE VOTING AVAILABLE (OUTSIDE)

COVID-19 Prevention Action Plan – Poll Places



Vallejo - Vallejo Women's Club



10x Social Distance Markers

MAXIMUM OCCUPANCY: 15

SIGN: DISCARD PENS AND SECRECY SLEEVES. (INSIDE)

SIGN: PHYSICAL DISTANCING INFO. (INSIDE)

SIGN: USE HAND SANITIZER (INSIDE)

SIGN (outside):
 1) MAXIMUM OCCUPANCY;
 2) USE HAND SANITIZER;
 3) PHYSICAL DISTANCING INFO;

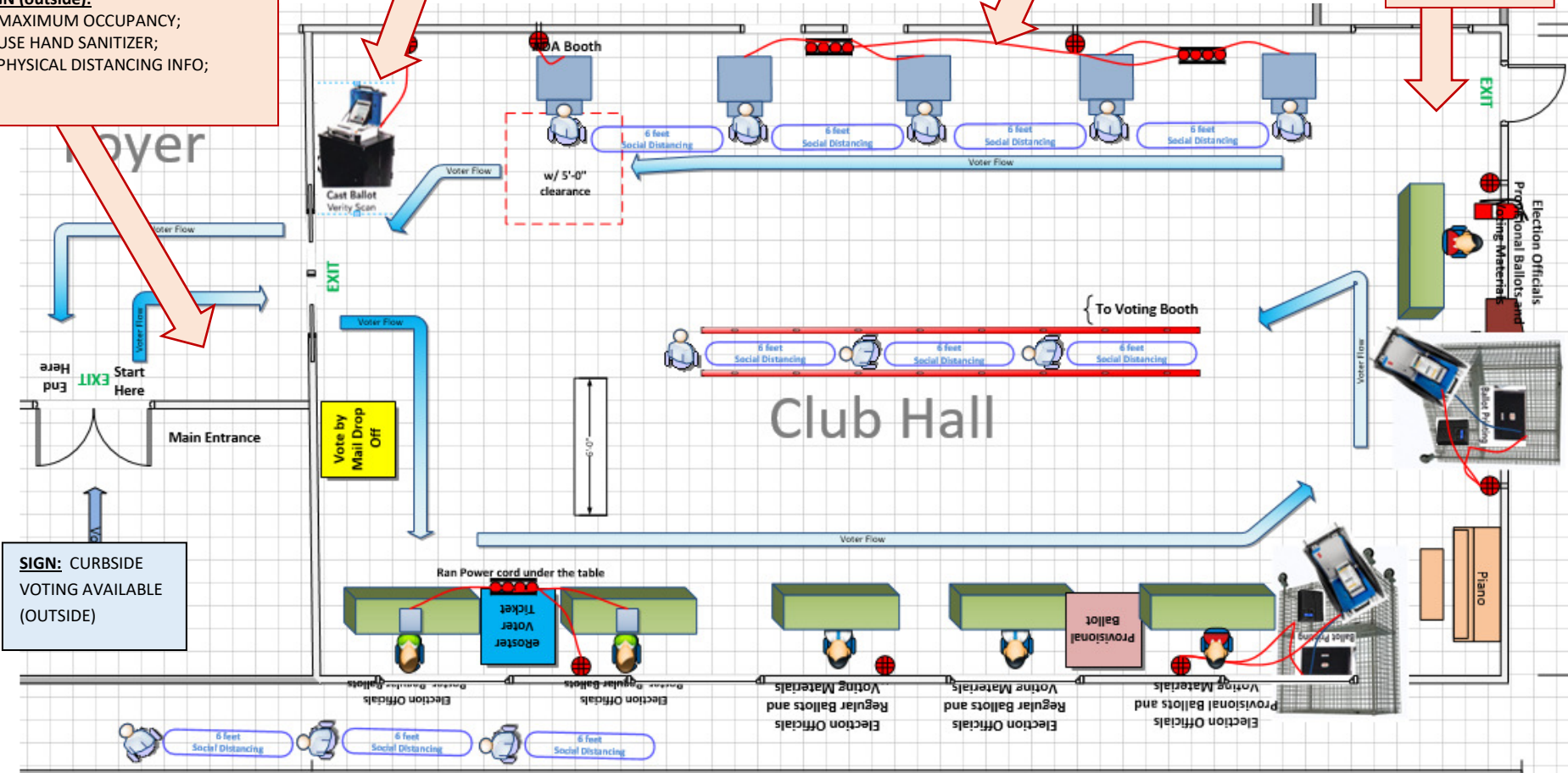

COVID-19 Prevention Action Plan – Poll Places



Vallejo – Wayside Church



10x Social Distance Markers

SIGN (outside):
 1) MAXIMUM OCCUPANCY;
 2) USE HAND SANITIZER;
 3) PHYSICAL DISTANCING INFO;

MAXIMUM OCCUPANCY: 10

SIGN: CURBSIDE VOTING AVAILABLE (OUTSIDE)

SIGN: USE HAND SANITIZER (INSIDE)

SIGN: PHYSICAL DISTANCING INFO. (INSIDE)

SIGN: DISCARD PENS AND SECRECY SLEEVES. (INSIDE)

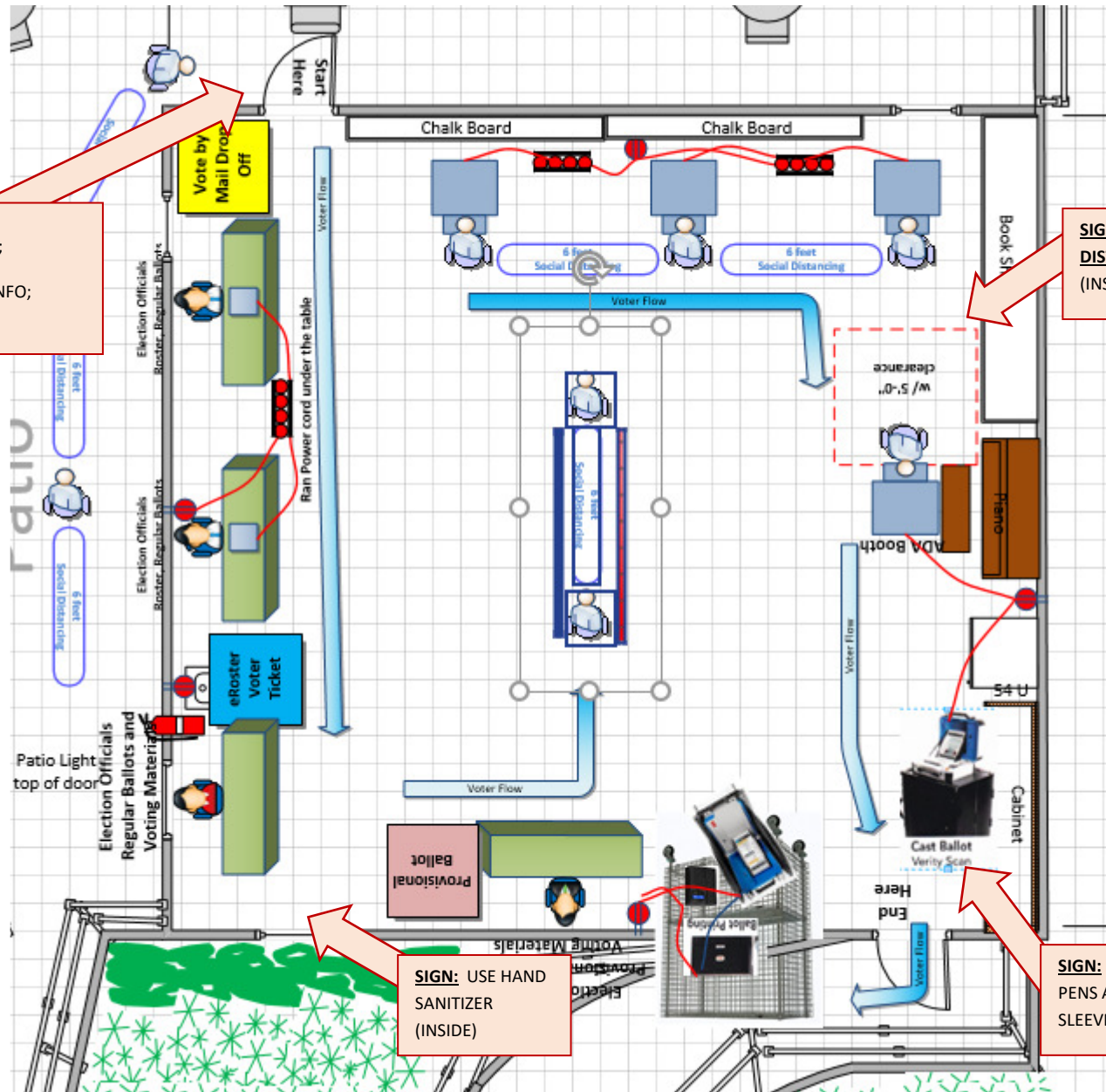

COVID-19 Prevention Action Plan – Poll Places



Vallejo – Solano Middle School:



20x Social Distance Markers

**MAXIMUM
OCCUPANCY:
30**

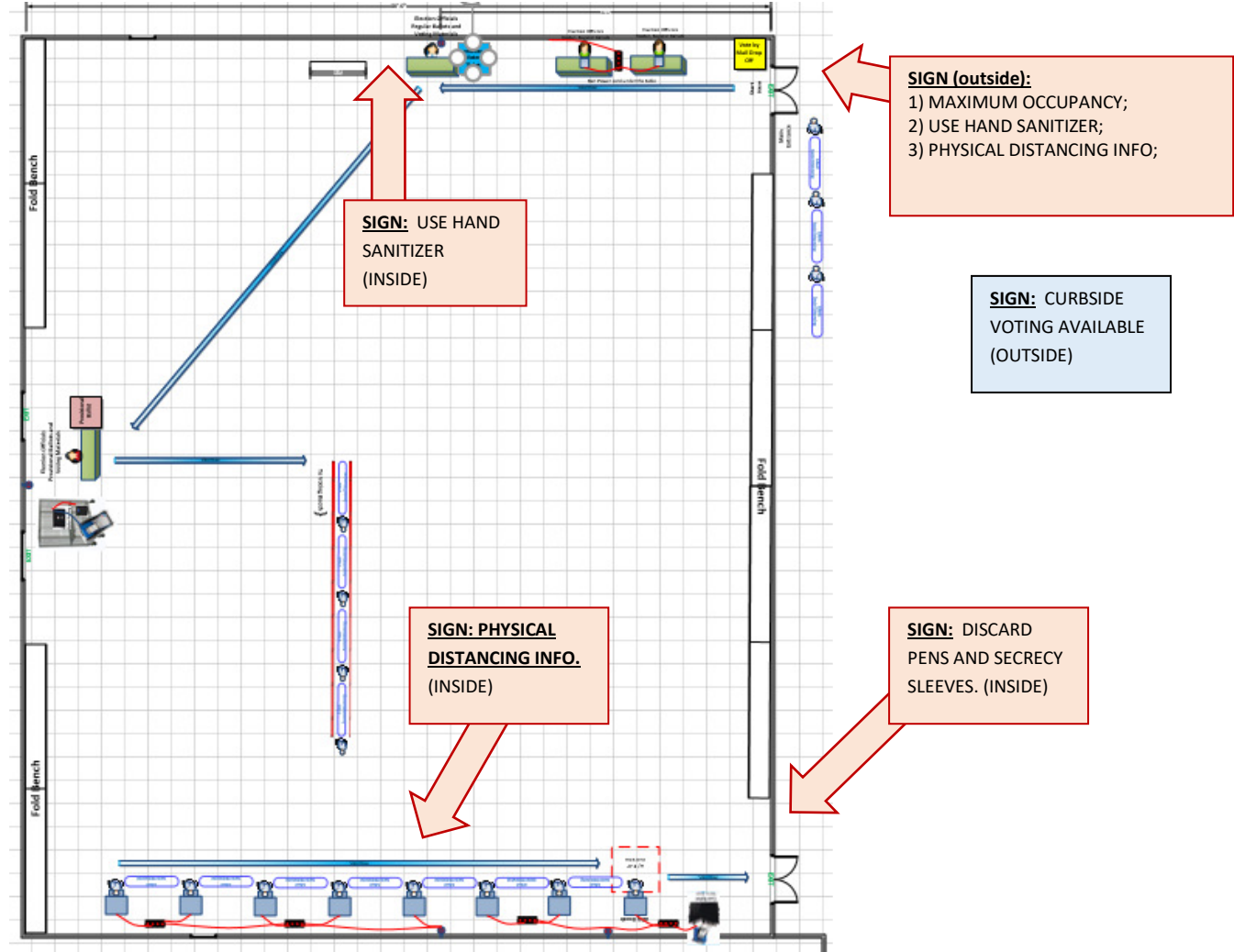

COVID-19 Prevention Action Plan – Poll Places



Vallejo – Impact Bible Ministries:



10x Social Distancing

MAXIMUM OCCUPANCY: 10

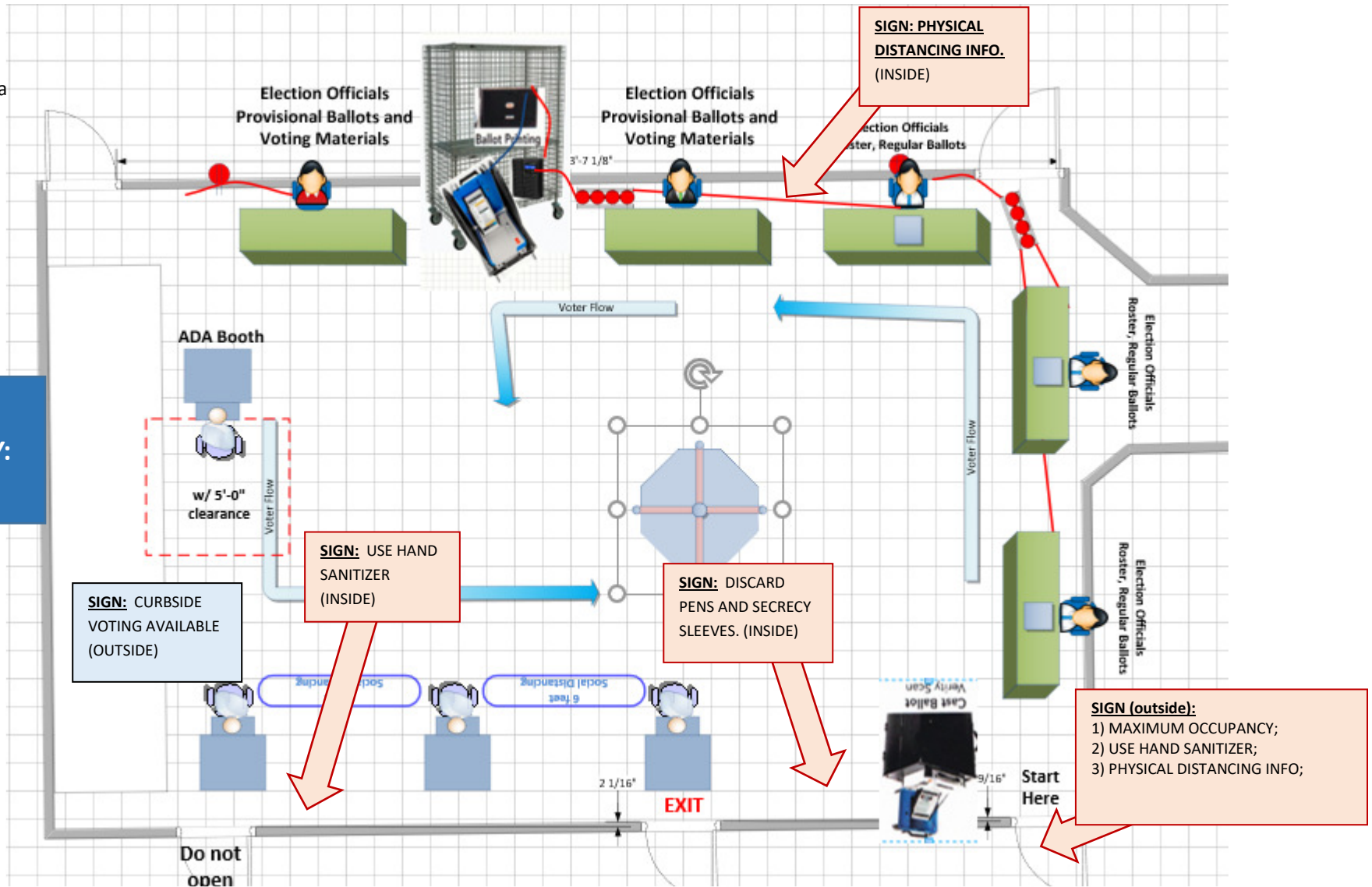

COVID-19 Prevention Action Plan – Poll Places



Vallejo – Bay Terrace Theater:



10x Social Distance Markers

MAXIMUM OCCUPANCY:
15

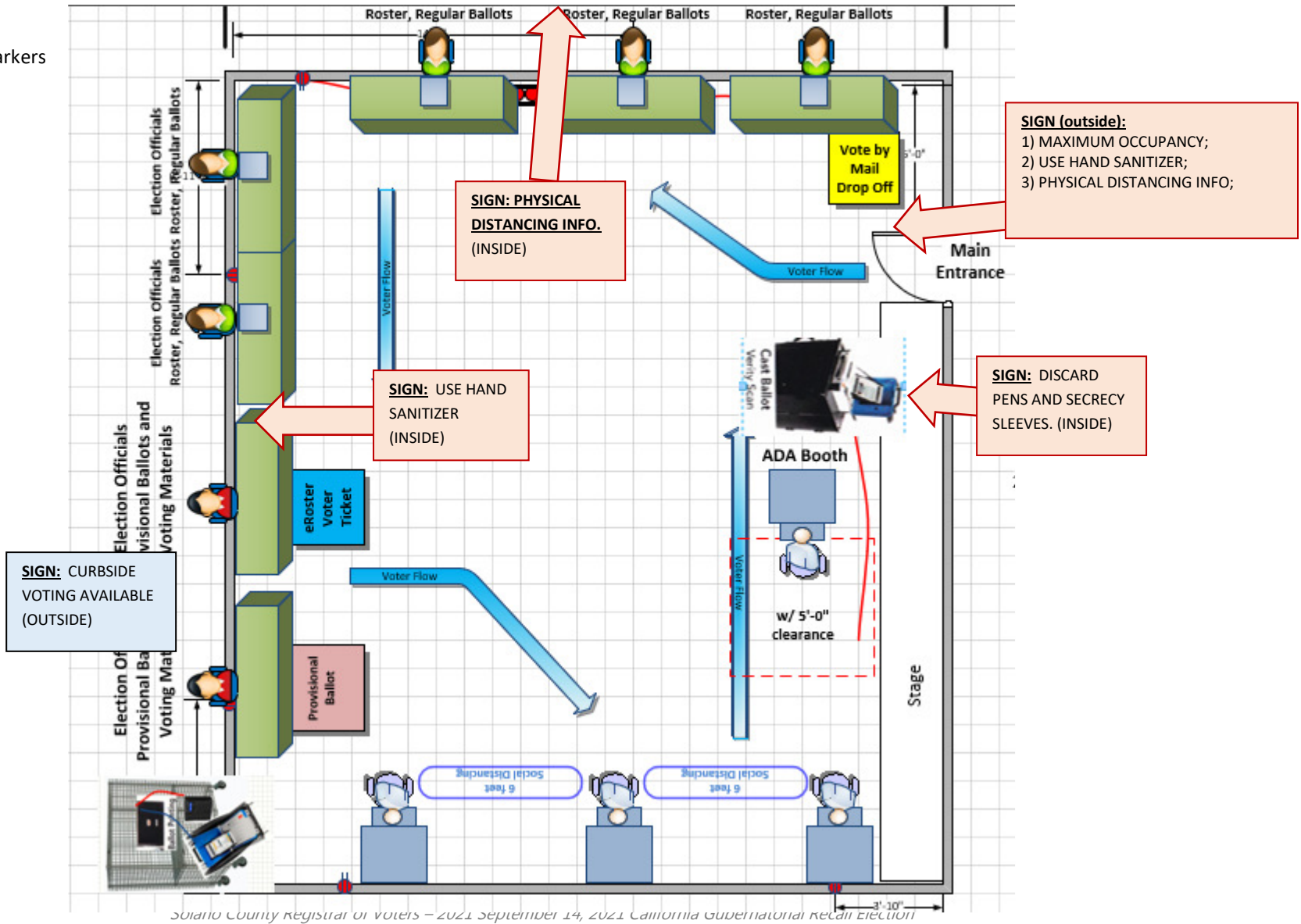



COVID-19 Prevention Action Plan – Poll Places

Appendix J: Other Information and Resources:

COVID-19 General Health and Safety Links

Centers for Disease Control (CDC):

www.cdc.gov/coronavirus/2019-ncov/index.html

CDC page on PPE, with guidelines for proper use of face coverings:

www.cdc.gov/coronavirus/2019-ncov/hcp/using-ppe.html

California Department of Public Health:

<https://covid19.ca.gov/industry-guidance/#top>

California Division of Occupational Safety and Health (Cal/OSHA):

www.dir.ca.gov/dosh/coronavirus/Health-Care-General-Industry.html

World Health Organization (WHO):

www.who.int/emergencies/diseases/novel-coronavirus-2019

Election-Specific Advice from Agencies and Institutions

U.S. Election Assistance Commission (EAC):

<https://www.eac.gov/election-officials/coronavirus-covid-19-resources>

U.S. Federal Voting Assistance Program (FVAP):

<https://www.fvap.gov/COVID-19>

U.S. Centers for Disease Control (CDC) Recommendations for Election Polling Locations:

www.cdc.gov/coronavirus/2019-ncov/community/election-polling-locations.html

Cybersecurity and Infrastructure Security Agency (CISA):

www.cisa.gov/covid-19-and-elections

National Association of Secretaries of State (NASS):

www.nass.org/resources/issue-briefing-election-emergencies-covid-19

National Association of State Election Directors (NASSED):

www.nased.org/covid19

National Conference of State Legislatures (NCSL):

www.ncsl.org/research/elections-andcampaigns/state-action-on-covid-19-and-elections.aspx

Massachusetts Institute of Technology (MIT) Election Data and Science Lab:

<https://electionlab.mit.edu/elections-and-covid-19>